

# Угловые запорные вентили 1610-1640, 1100, 1200, 1300, 1400

## Технические характеристики

По вопросам продаж и поддержки обращайтесь:

Алматы (7273)495-231  
Ангарск (3955)60-70-56  
Архангельск (8182)63-90-72  
Астрахань (8512)99-46-04  
Барнаул (3852)73-04-60  
Белгород (4722)40-23-64  
Благовещенск (4162)22-76-07  
Брянск (4832)59-03-52  
Владивосток (423)249-28-31  
Владикавказ (8672)28-90-48  
Владимир (4922)49-43-18  
Волгоград (844)278-03-48  
Вологда (8172)26-41-59  
Воронеж (473)204-51-73  
Екатеринбург (343)384-55-89

Иваново (4932)77-34-06  
Ижевск (3412)26-03-58  
Иркутск (395)279-98-46  
Казань (843)206-01-48  
Калининград (4012)72-03-81  
Калуга (4842)92-23-67  
Кемерово (3842)65-04-62  
Киров (8332)68-02-04  
Коломна (4966)23-41-49  
Кострома (4942)77-07-48  
Краснодар (861)203-40-90  
Красноярск (391)204-63-61  
Курск (4712)77-13-04  
Курган (3522)50-90-47  
Липецк (4742)52-20-81

Магнитогорск (3519)55-03-13  
Москва (495)268-04-70  
Мурманск (8152)59-64-93  
Набережные Челны (8552)20-53-41  
Нижний Новгород (831)429-08-12  
Новокузнецк (3843)20-46-81  
Ноябрьск (3496)41-32-12  
Новосибирск (383)227-86-73  
Омск (3812)21-46-40  
Орел (4862)44-53-42  
Оренбург (3532)37-68-04  
Пенза (8412)22-31-16  
Петрозаводск (8142)55-98-37  
Псков (8112)59-10-37  
Пермь (342)205-81-47

Ростов-на-Дону (863)308-18-15  
Рязань (4912)46-61-64  
Самара (846)206-03-16  
Санкт-Петербург (812)309-46-40  
Саратов (845)249-38-78  
Севастополь (8692)22-31-93  
Саранск (8342)22-96-24  
Симферополь (3652)67-13-56  
Смоленск (4812)29-41-54  
Сочи (862)225-72-31  
Ставрополь (8652)20-65-13  
Сургут (3462)77-98-35  
Сыктывкар (8212)25-95-17  
Тамбов (4752)50-40-97  
Тверь (4822)63-31-35

Тольятти (8482)63-91-07  
Томск (3822)98-41-53  
Тула (4872)33-79-87  
Тюмень (3452)66-21-18  
Ульяновск (8422)24-23-59  
Улан-Удэ (3012)59-97-51  
Уфа (347)229-48-12  
Хабаровск (4212)92-98-04  
Чебоксары (8352)28-53-07  
Челябинск (351)202-03-61  
Череповец (8202)49-02-64  
Чита (3022)38-34-83  
Якутск (4112)23-90-97  
Ярославль (4852)69-52-93

Россия +7(495)268-04-70

Казахстан +7(7172)727-132

Киргизия +996(312)96-26-47

эл.почта: [fro@nt-rt.ru](mailto:fro@nt-rt.ru) || сайт: <https://far.nt-rt.ru/>

**ART.1610**

Chrome-plated angled thermostatic valve.

- FAR 24x19 connection
- Size: 3/8" - 1/2"

**ART.1620\***

Chrome-plated angled thermostatic valve.

- Iron pipe connection
- Size: 3/8" - 1/2" - 3/4" - 1"

**ART.1630**

Chrome-plated straight thermostatic valve.

- FAR 24x19 connection
- Size: 3/8" - 1/2"

**ART.1640\***



Chrome-plated straight thermostatic valve.

- Iron pipe connection
- Size: 3/8" - 1/2" - 3/4" - 1"

**ART.1100**

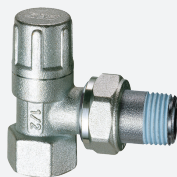

Chrome-plated angled lockshield valve.

- FAR 24x19 connection
- Size: 3/8" - 1/2"

**ART.1200**

Chrome-plated angled lockshield valve.

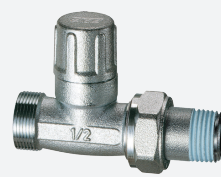
- Iron pipe connection
- Size: 3/8" - 1/2" - 3/4" - 1"

**ART.1300**

Chrome-plated straight lockshield valve.

- FAR 24x19 connection
- Size: 3/8" - 1"

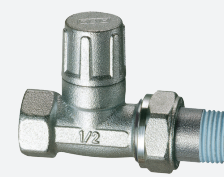
**ART.1400**

Chrome-plated straight lockshield valve.

- Iron pipe connection
- Size: 3/8" - 1/2" - 3/4" - 1"

\*The valves, art. 1620 12 and 1640 12, comply with the EN215 standard in combination with the thermostatic head, art. 1828 (ST.07.15)

## 1 DESCRIPTION

FAR thermostatic valves are preset for assembly of thermostatic and thermo-electric actuators, which control opening and closure.

### 1.1 SPACE SAVING THERMOSTATIC VALVES

In addition to thermostatic valves suitable for normal positioning of thermostatic or thermoelectric heads, Far offers space-saving valves which permit a choice of direction dependant on system constraints and available space.

**ART.1616**

Chrome-plated thermostatic valve, left-angled version.

- FAR 24x19 connection
- Size: 3/8" - 1/2"

**ART.1626**

Chrome-plated thermostatic valve, left-angled version.

- Iron pipe connection
- Size: 3/8" - 1/2"

**ART.1617**

Chrome-plated thermostatic valve, right-angled version.

- FAR 24x19 connection
- Size: 3/8" - 1/2"

**ART.1627**

Chrome-plated thermostatic valve, right-angled version.

- Iron pipe connection
- Size: 3/8" - 1/2"

**ART.1117**

Chrome-plated lockshield valve, right-angled version.

- FAR 24x19 connection
- Size: 3/8" - 1/2"

**ART.1127**

Chrome-plated lockshield valve, right-angled version.

- Iron pipe connection
- Size: 3/8" - 1/2"

**ART.1116**

Chrome-plated lockshield valve, left-angled version.

- FAR 24x19 connection
- Size: 3/8" - 1/2"

**ART.1126**

Chrome-plated lockshield valve, left-angled version.

- Iron pipe connection
- Size: 3/8" - 1/2"

**ART.1615**

Chrome-plated angled thermostatic valve with horizontal control.

- FAR 24x19 connection
- Size: 3/8" - 1/2"

Chrome-plated angled thermostatic valve with horizontal control.

- Iron pipe connection
- Size: 3/8" - 1/2"

**ART.1625**

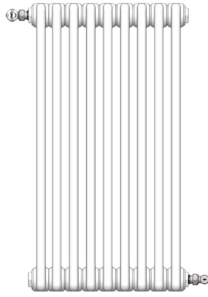

## 1.2 EXAMPLES OF INSTALLATION

A variety of methods is available for connecting radiators into a distribution network, but the most commonly used are the following: lateral, opposite and bottom connection.

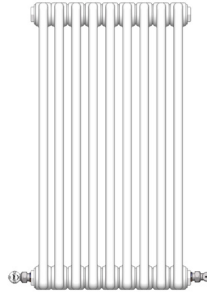

### OPPOSITE CONNECTION

This method ensures maximum efficiency as hot water has to pass through the whole heating body of the radiator. From an installation point of view, however, the situation is more complicated because it is necessary to be aware of the centre line between valve and lockshield valve, and the length of the radiator.



### BOTTOM CONNECTION

This is the least used and is achieved by making both connections at the bottom. Heat release is reduced from 5% to 10% , as water flow has a direct path towards exiting from the radiator.

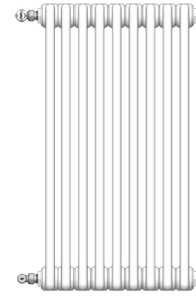

### LATERAL CONNECTION

Lateral is the most common type of connection: it permits good radiator efficiency and easy installation as the only thing necessary bear in mind is the centre line between valve and lockshield valve.

Installation overview of art.1617-1116

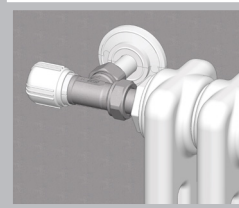
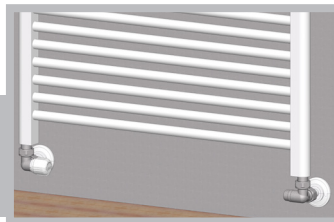

Installation overview of art.1615

## 2 CONSTRUCTION FEATURES

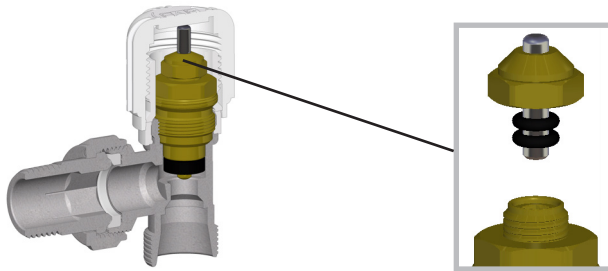

It is possible to replace sealing O-Ring within the body of the valve without draining down the system.

### CONICAL THREAD WITH SEALING ADHESIVE



Terminals have conical thread and are provided with Loctite® Dri-Seal 5061 which guarantees seal on standard thread.

### SEAT IN HPF



Seal between terminal and body is achieved by means of a seat in HPF, which guarantees reliability and durability.

Installation of thermostatic and thermo-electric heads can be carried out removing the handle and the plastic component.

Unscrew the handle, insert the green extractor on the stainless steel pin and rescrew the handle. In this way it is possible to remove the handle and the plastic component without damaging them in order to install the desired head.

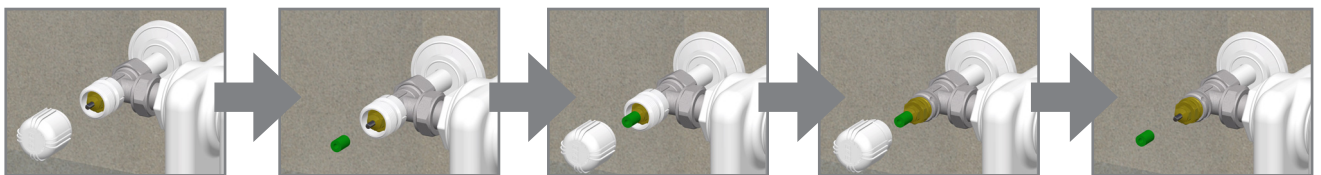

## 3 BUILDING MATERIALS

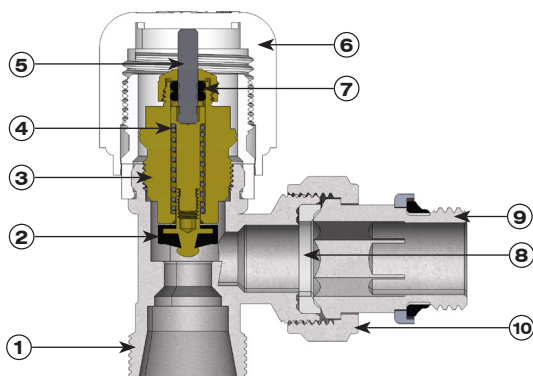

- |                            |                |
|----------------------------|----------------|
| 1.Valve body               | CW617N brass   |
| 2.Shutter                  | EPDM           |
| 3.Body                     | CW614N brass   |
| 4.Spring                   | AISI 302 steel |
| 5.Pin                      | AISI 302 steel |
| 6.Handle                   | ABS            |
| 7.Sealing                  | O-Rings EPDM   |
| 8.Sealing seat             | HPF            |
| 9.Terminal body            | CW617N brass   |
| 10.Tightening terminal nut | CW617N brass   |

4 INSTALLABLE COMPONENTS

FAR manual valves and lockshield valves are available with iron connection and with interchangeable connections for copper, plastic and multilayer pipe.

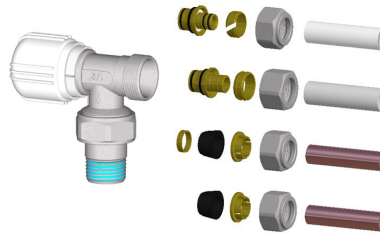

- MULTILAYER
- PLASTIC
- Ø10-12-14 mm COPPER
- Ø15-16 mm COPPER

4.1 INSTALLATION OF THERMOSTATIC AND THERMO-ELECTRIC HEAD

The thermostatic heads allow the automatic opening and closing of the valve on which they are installed in order to obtain the set comfort temperature.

ART.1824



\* In order to know the features of the thermostatic head, art. 1824, look at the data sheet ST.07.02

ART.1828



\* In order to know the features of the thermostatic head, art. 1828, look at the data sheet ST.07.15



**The thermostatic controls must not be installed vertically!**  
For a correct measurement of the room temperature, no disturbing elements must be present (furniture components, wall niches, etc.) that could affect its normal operation.

In the event that the temperature reading can be influenced by environmental factors or in case of installations that require the need for a thermostatic control placed vertically, two thermostatic controls with remote temperature sensor are available:

To guarantee correct temperature sensing and regulation - even in situations where heat emitters are affected by other constraints within the room, FAR offers two other systems for detecting room temperature:



ART.1800

**Main features**

- Thermostatic head with liquid sensor
  - Remote selector numbered from 1 to 5
  - Length of capillary: 2m
  - Temperature range: 0° + 28°C
- (The values for the temperature setting are standard for all thermostatic models and are shown on the technical data sheet ST.07.02)



ART.1810

**Thermostatic head with sensor and graduated scale for selection of remote temperature value.**

The sensor, which features a graduated temperature scale, is placed on the wall in the vicinity of the heat emitter but remote from it by up to 2m. It should be located in an open area with no barriers to free movement of room air. This product is suitable for use with heat emitters located in recesses, or concealed within decorative cabinets, or behind curtains of thick material where free circulation of room air is inhibited.

**Thermostatic head and remote sensor.**

The sensor is placed at a maximum distance of 2m, usually on the skirting board under the heat emitter, in such a way as to be in the airflow drawn by the radiator or convector itself, which will average the temperature of room air as a whole.

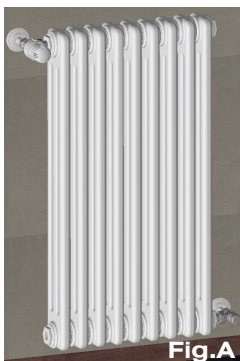

Fig.A

In the following illustrations you can see how the radiator - installed on the free wall (pic.A) - permits installation of art.1824-1828, as the sensor is in contact with circulating air, without any special materials, which might influence the recorded temperature. On the other hand if the radiator is installed in a recess (pic.B) or in presence of furniture, which could interfere with the exact measurement of temperature near the heat emitter, FAR suggests application of art.1800 or art.1810.

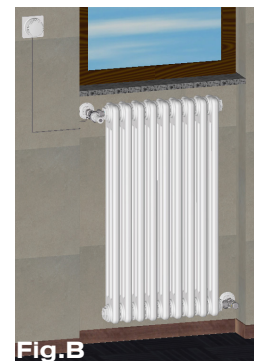

Fig.B

4.2 THERMO - ELECTRIC HEADS

FAR thermo-electric heads are available in two versions: with auxiliary micro-switch (**pic.B**) or without (**pic.A**). These heads are activated or deactivated by a thermostat or a control unit. They are available normally open or normally closed with 24V or 230V voltage.



Art.1909-1919-1929-1939

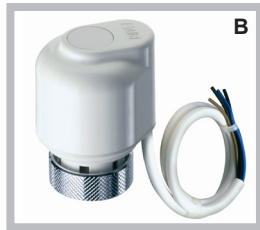

Art.1914-1924-1913-1923

Once the handle and the plastic component have been removed, it is possible to install the thermo-electric head as follows:  
 1) screw the adapter (art. 1941) on the valve  
 2) assemble thermo-electric head

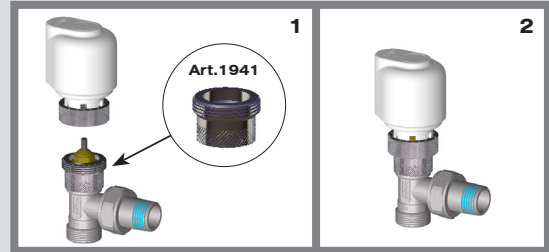

4.3 COMPLEMENTARY ACCESSORIES

CHROME-PLATED TELESCOPIC TERMINAL	CHROME-PLATED STRAIGHT EXTENSION	CHROME-PLATED REDUCER	CHROME-PLATED SPECIAL ELBOW WITH 24X19 CONNECTION AND Ø16 CUT PIPE	ECCENTRIC FITTING
To cover the distance between valve and radiator 3/8": extension from 32 mm to 55 mm 1/2": extension from 35 mm to 60 mm	Permits changing a FAR 24x19 female thread in a Ø18-22 connection for copper pipe. Available with 30-35-40 mm extension.	Permits changing a FAR 24X19 female thread in a 1/2" female thread.	Available with 30 and 100 mm length.	Available sizes: 1-2-3-4-5-6 cm with 3/8"-1/2"-3/4" thread, in male-male and male-female versions.
ART.8820	ART.8850	ART.8870	ART.8900	ART.5560

5 FLUJDINAMIC AND TECHNICAL FEATURES

The fluid dynamic characteristics of the thermostatic valves were determined in combination with the thermostatic head, art.1828

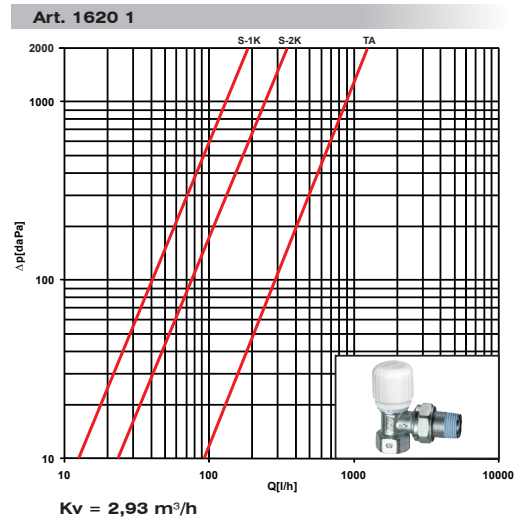
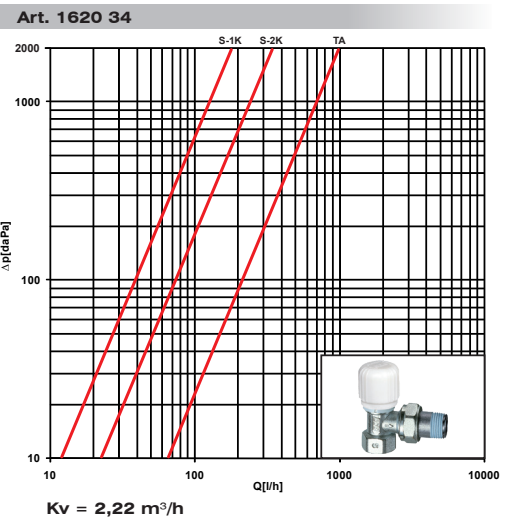
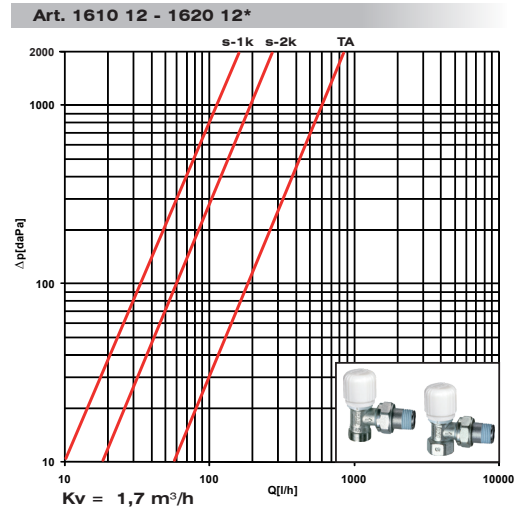
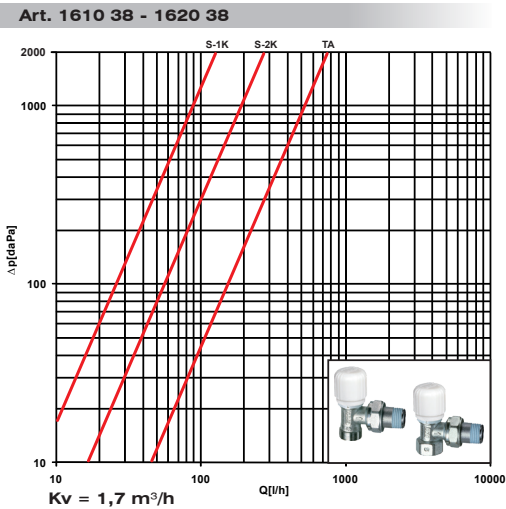

Art. 1630 38 - 1640 38

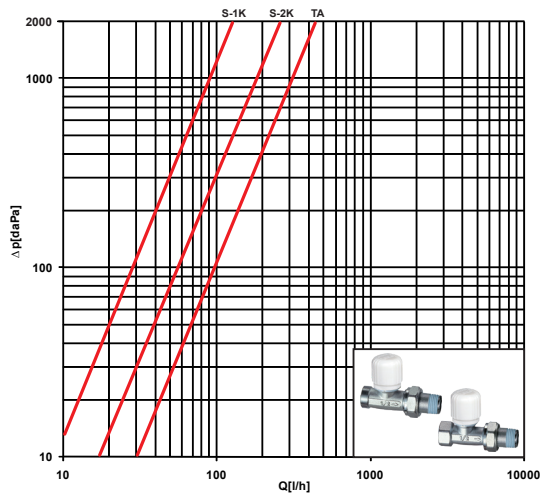

$K_v = 1,1 \text{ m}^3/\text{h}$

Art. 1630 12- 1640 12\*

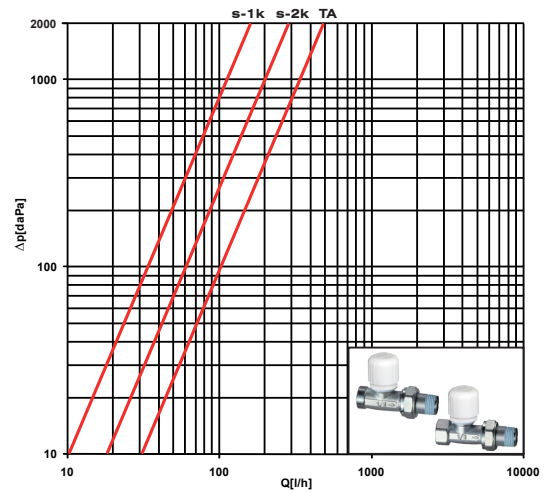

$K_v = 1,25 \text{ m}^3/\text{h}$

\* In compliance with the EN215 standard in combination with the thermostatic head, art.1828, (ST.07.15)

Art. 1640 34

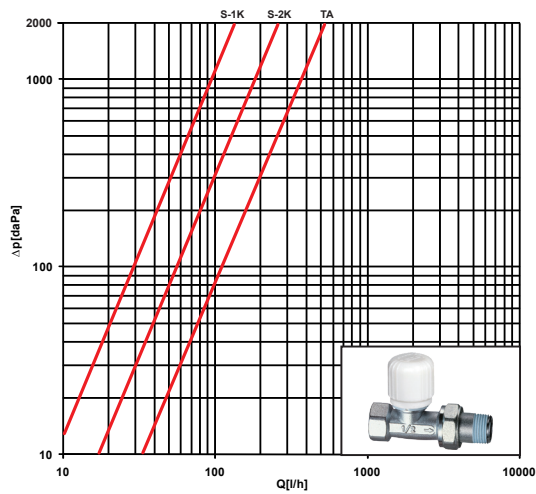

$K_v = 1,21 \text{ m}^3/\text{h}$

Art. 1640 1

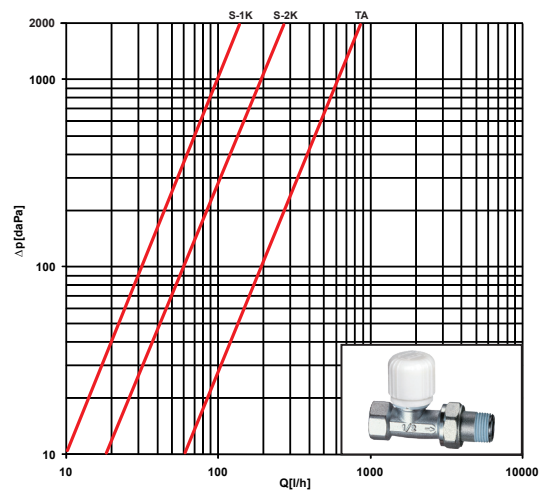

$K_v = 2 \text{ m}^3/\text{h}$

Art. 1616 38 - 1617 38 - 1626 38 - 1627 38

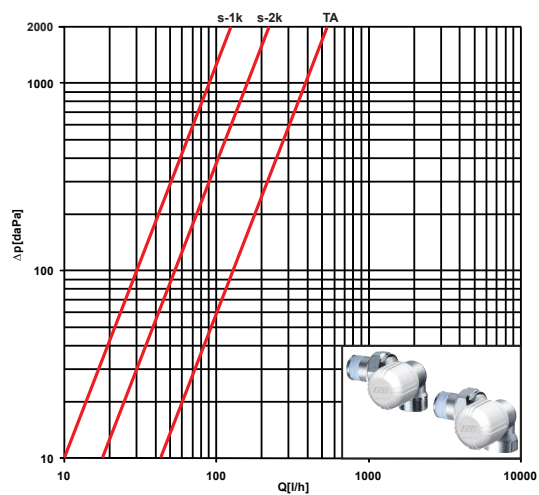

$K_v = 1,12 \text{ m}^3/\text{h}$

Art. 1616 12 - 1617 12 - 1626 12 - 1627 12

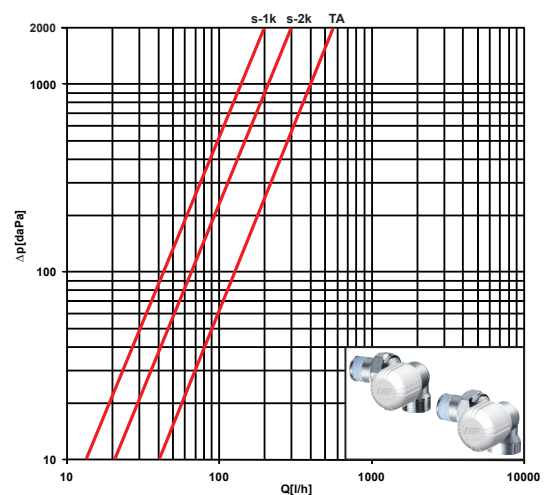

$K_v = 1,2 \text{ m}^3/\text{h}$

## Art. 1615 12 - 1625 12

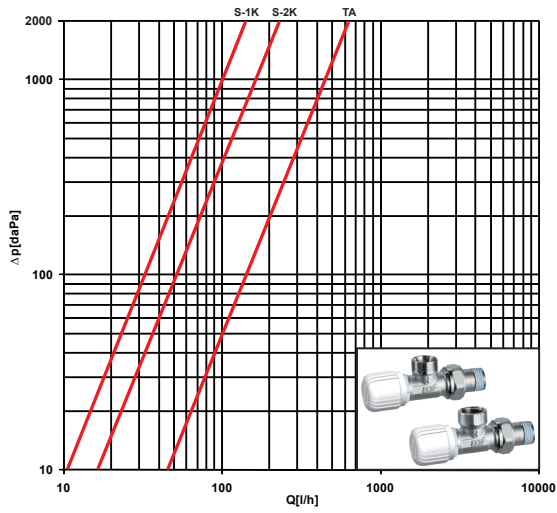

$K_v = 1,42 \text{ m}^3/\text{h}$

## Art. 1100 38 - 1200 38

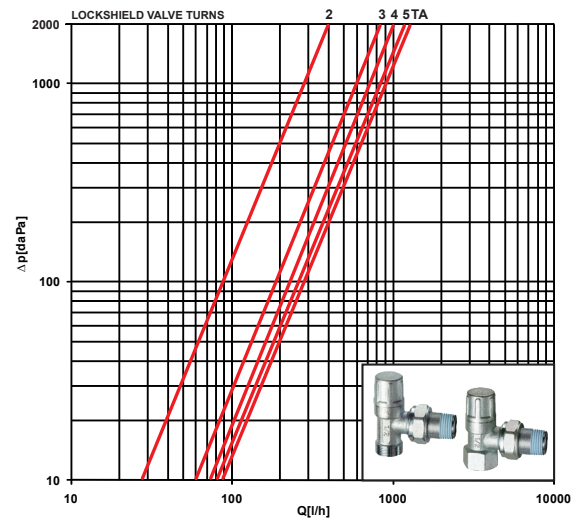

TURNS	2	3	4	5	TA
$K_v$ [m <sup>3</sup> /h]	0.83	1.75	2.1	2.26	2.35

## Art. 1100 12 - 1200 12

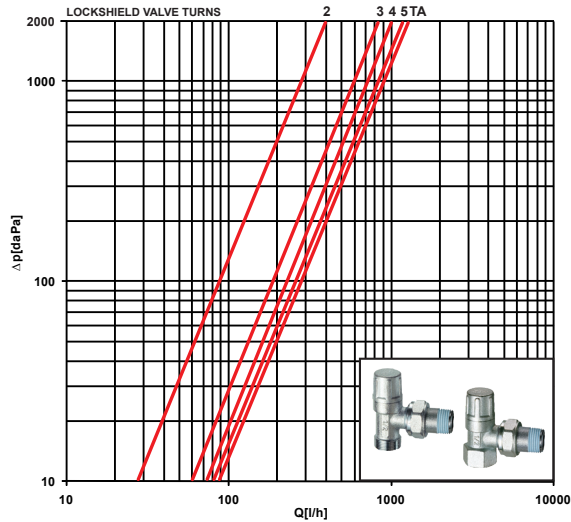

TURNS	2	3	4	5	TA
$K_v$ [m <sup>3</sup> /h]	0.87	1.84	2.18	2.47	2.65

## Art. 1200 34

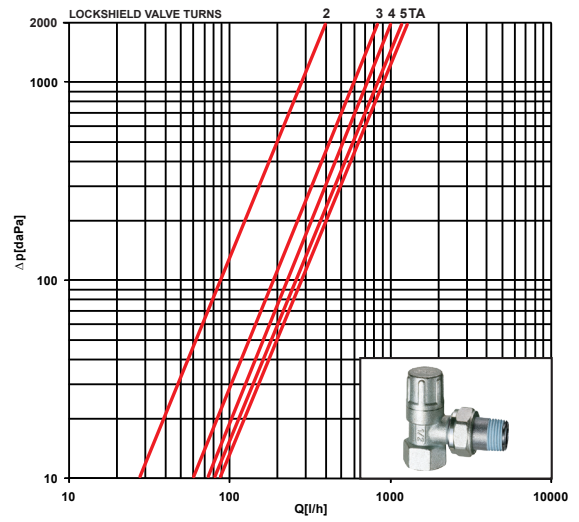

TURNS	2	3	4	5	TA
$K_v$ [m <sup>3</sup> /h]	1.39	2.14	2.95	4	5

## Art. 1200 1

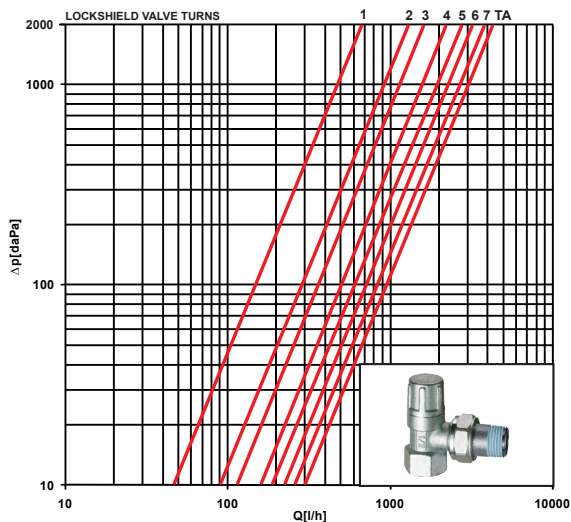

TURNS	1	2	3	4	5	6	7	TA
$K_v$ [m <sup>3</sup> /h]	1,49	3	3,89	5,2	6	7,41	8,55	9,9

## Art. 1300 38- 1400 38

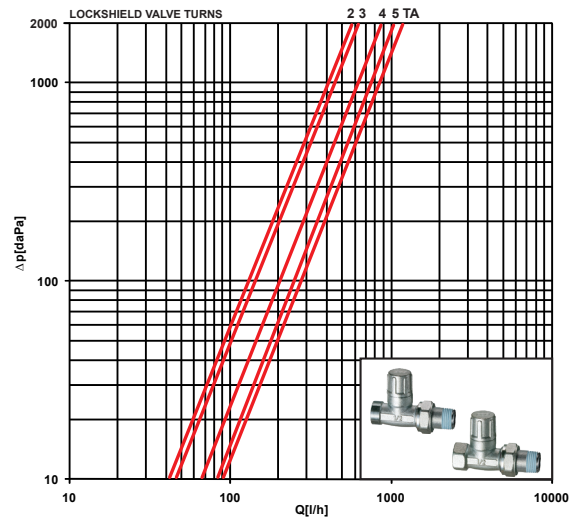

TURNS	2	3	4	TA
$K_v$ [m <sup>3</sup> /h]	0,75	1,14	1,41	1,52

Art. 1300 12- 1400 12

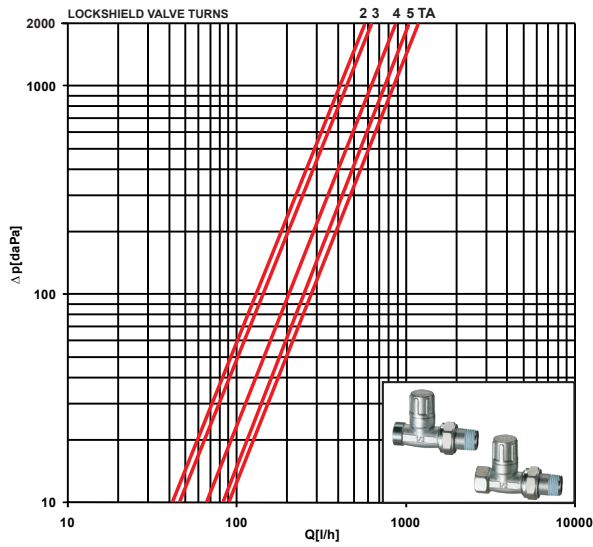

TURNS	2	3	4	TA
Kv [m³/h]	0,7	1,13	1,46	1,56

Art. 1400 34

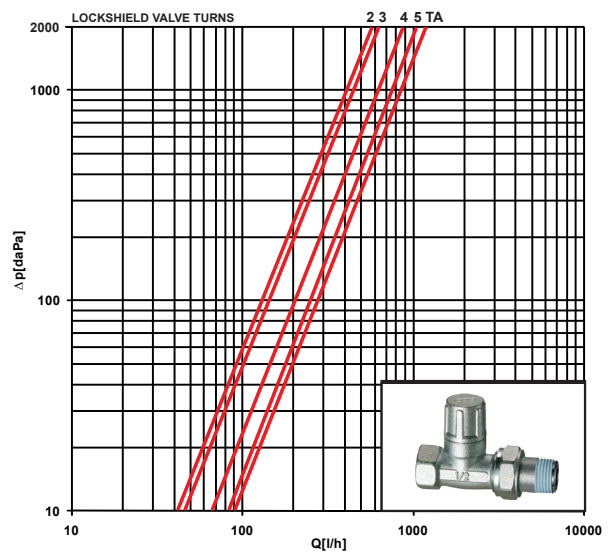

TURNS	2	3	4	5	TA
Kv [m³/h]	1.25	1.42	1.94	2.4	2.5

Art. 1400 1

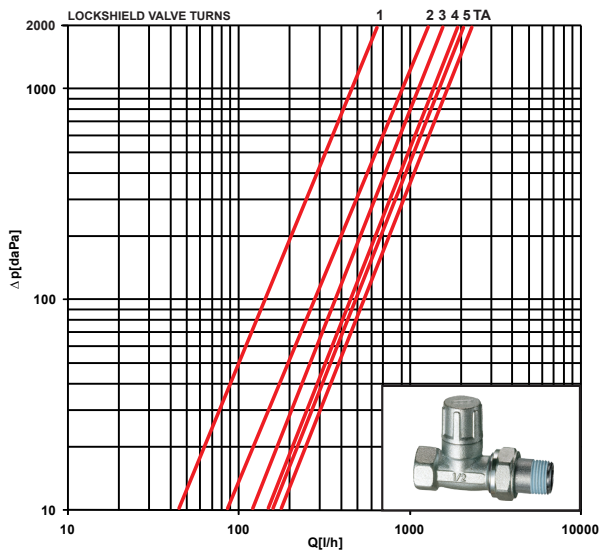

TURNS	1	2	3	4	5	TA
Kv [m³/h]	1.46	2.57	3.65	4.15	4.5	5

Art. 1116 38 - 1117 38 - 1126 38 - 1127 38

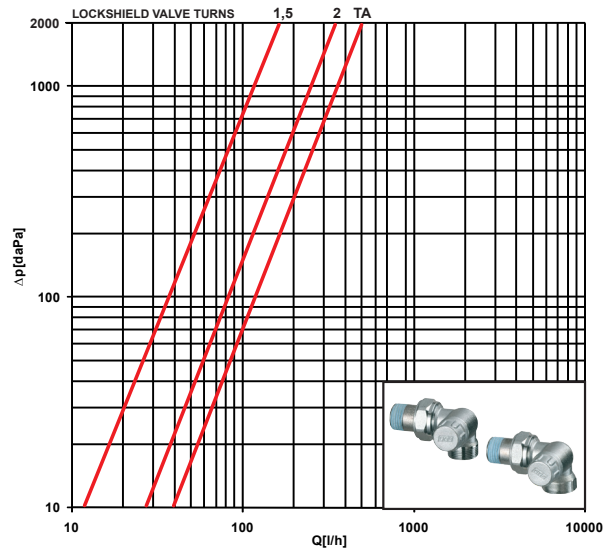

TURNS	1,5	2	TA
Kv [m³/h]	0,16	0,72	1,1

Art. 1116 12 - 1117 12 - 1126 12 - 1127 12

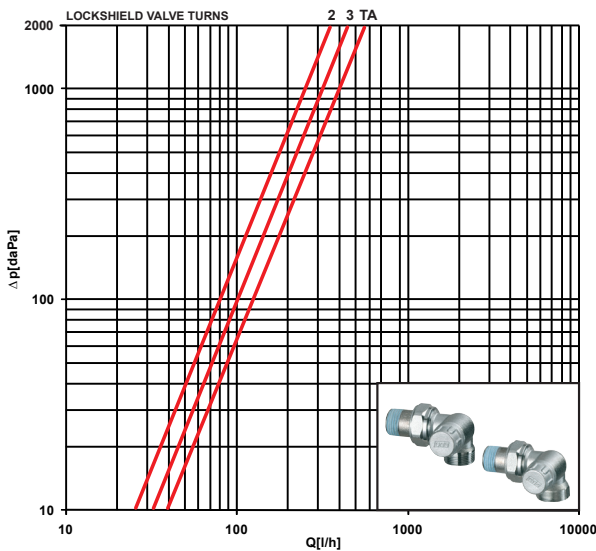

TURNS	2	3	TA
Kv [m³/h]	0,8	1	1,25

\* The valves, art. 1620 12 and 1640 12, comply with the EN215 standard in combination with the thermostatic head, art.1828 (ST.07.15)

## 6 TECHNICAL FEATURES

**Nominal pressure:** 10 bar  
**Max temperature:** 95°C  
**Compatible media:** water, water with glycol



## 7 DIMENSIONAL HEAD FEATURES

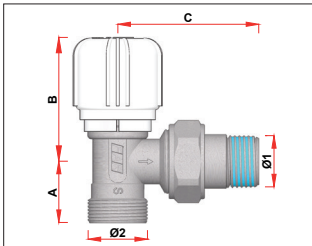

\* = with thermostatic head Art.1824

**ART. 1610**

CODE	Ø1	Ø2	A	B	C
1610 38	3/8"	24x19	24	50 (98*)	49
1610 12	1/2"	24x19	24	50 (98*)	56

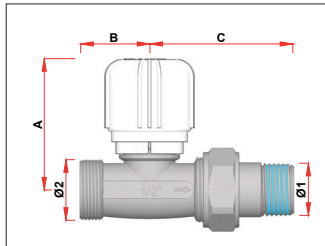

\* = with thermostatic head Art.1824

**ART. 1630**

CODE	Ø1	Ø2	A	B	C
1630 38	3/8"	24x19	52 (100*)	27	50
1630 12	1/2"	24x19	52 (100*)	28	57

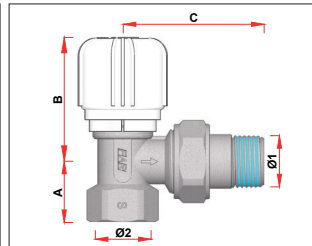

\* = with thermostatic head Art.1824

**ART. 1620**

CODE	Ø1	Ø2	A	B	C
1620 38	3/8"	3/8"	20	50 (98*)	49
1620 12	1/2"	1/2"	24	50 (98*)	56
1620 34	3/4"	3/4"	28	52 (100*)	64
1620 1	1"	1"	34	52 (100*)	75

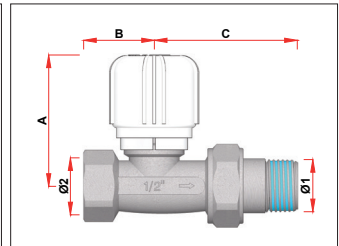

\* = with thermostatic head Art.1824

**ART. 1640**

CODE	Ø1	Ø2	A	B	C
1640 38	3/8"	3/8"	52 (100*)	24	50
1640 12	1/2"	1/2"	52 (100*)	28	57
1640 34	3/4"	3/4"	54 (102*)	32	66
1640 1	1"	1"	54 (102*)	40	68

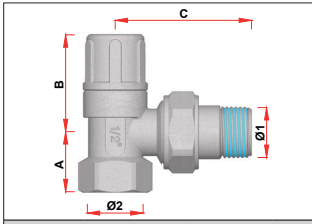

**ART. 1200**

CODE	Ø1	Ø2	A	B	C
1200 38	3/8"	3/8"	20	39	49
1200 12	1/2"	1/2"	24	40	56
1200 34	3/4"	3/4"	28	47	64
1200 1	1"	1"	34	51	75

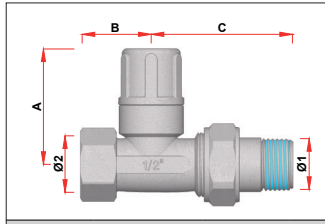

**ART. 1400**

CODE	Ø1	Ø2	A	B	C
1400 38	3/8"	3/8"	44	24	50
1400 12	1/2"	1/2"	46	28	57
1400 34	3/4"	3/4"	55	32	66
1400 1	1"	1"	61	40	68

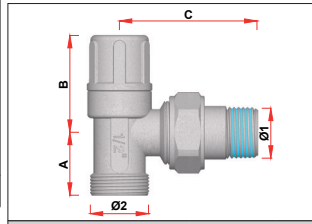

**ART. 1100**

CODE	Ø1	Ø2	A	B	C
1100 38	3/8"	24x19	25	39	49
1100 12	1/2"	24x19	25	40	56

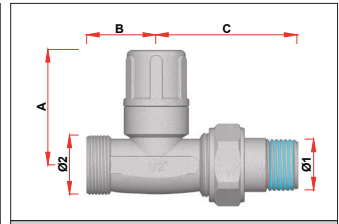

**ART. 1300**

CODE	Ø1	Ø2	A	B	C
1300 38	3/8"	24x19	44	27	50
1300 12	1/2"	24x19	46	28	57

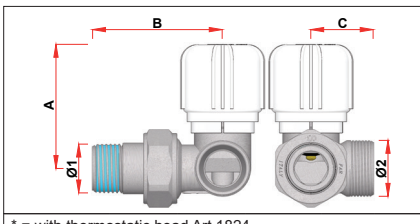

\* = with thermostatic head Art.1824

**ART. 1616-1617**

CODE	Ø1	Ø2	A	B	C
1616 38	3/8"	24x19	53 (101*)	52	26
1616 12	1/2"	24x19	53 (101*)	55	26
1617 38	3/8"	24x19	53 (101*)	52	26
1617 12	1/2"	24x19	53 (101*)	55	26

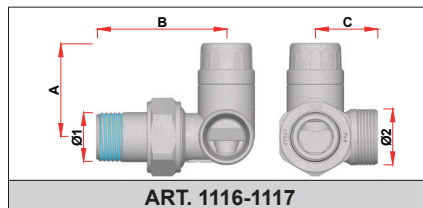

**ART. 1116-1117**

CODE	Ø1	Ø2	A	B	C
1116 38	3/8"	24x19	40	52	26
1116 12	1/2"	24x19	40	55	26
1117 38	3/8"	24x19	40	52	26
1117 12	1/2"	24x19	40	55	26

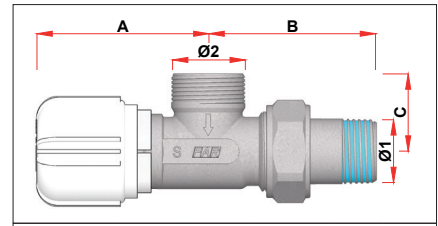

\* = with thermostatic head Art.1824

**ART. 1615**

CODE	Ø1	Ø2	A	B	C
1615 38	3/8"	24x19	55 (103*)	52	25
1615 12	1/2"	24x19	55 (103*)	56	25

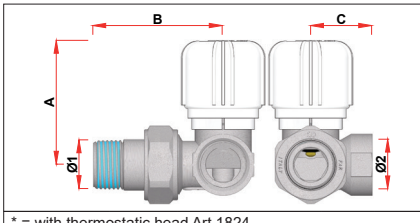

\* = with thermostatic head Art.1824

**ART. 1626-1627**

CODE	Ø1	Ø2	A	B	C
1626 38	3/8"	3/8"	53 (101*)	52	26
1626 12	1/2"	1/2"	53 (101*)	55	26
1627 38	3/8"	3/8"	53 (101*)	52	26
1627 12	1/2"	1/2"	53 (101*)	55	26

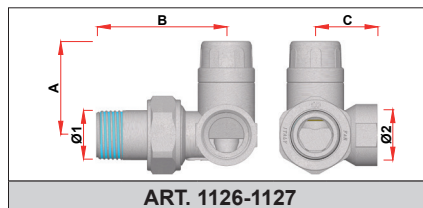

**ART. 1126-1127**

CODE	Ø1	Ø2	A	B	C
1126 38	3/8"	3/8"	40	52	26
1126 12	1/2"	1/2"	40	55	26
1127 38	3/8"	3/8"	40	52	26
1127 12	1/2"	1/2"	40	55	26

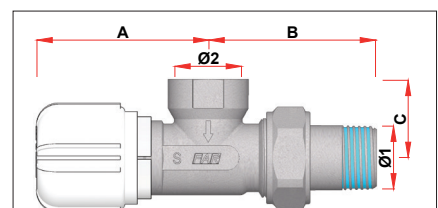

\* = with thermostatic head Art.1824

**ART. 1625**

CODE	Ø1	Ø2	A	B	C
1625 12	1/2"	1/2"	55 (103*)	56	25

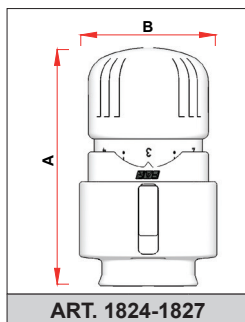

**ART. 1824-1827**

CODE	A	B
1824	86	48
1827	86	48

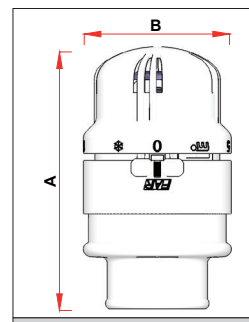

**ART. 1828**

CODE	A	B
1828	91	51

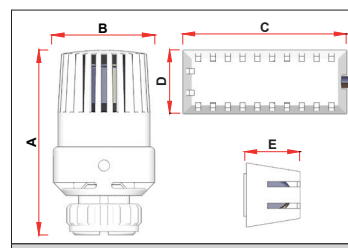

**ART. 1810**

CODE	A	B	C	D	E
1810	98	55	85	33	27

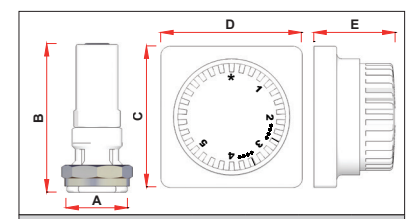

**ART. 1800**

CODE	A	B	C	D	E
1800	36	83	79	79	50

## По вопросам продаж и поддержки обращайтесь:

Алматы (7273)495-231  
Ангарск (3955)60-70-56  
Архангельск (8182)63-90-72  
Астрахань (8512)99-46-04  
Барнаул (3852)73-04-60  
Белгород (4722)40-23-64  
Благовещенск (4162)22-76-07  
Брянск (4832)59-03-52  
Владивосток (423)249-28-31  
Владикавказ (8672)28-90-48  
Владимир (4922)49-43-18  
Волгоград (844)278-03-48  
Вологда (8172)26-41-59  
Воронеж (473)204-51-73  
Екатеринбург (343)384-55-89

Иваново (4932)77-34-06  
Ижевск (3412)26-03-58  
Иркутск (395)279-98-46  
Казань (843)206-01-48  
Калининград (4012)72-03-81  
Калуга (4842)92-23-67  
Кемерово (3842)65-04-62  
Киров (8332)68-02-04  
Коломна (4966)23-41-49  
Кострома (4942)77-07-48  
Краснодар (861)203-40-90  
Красноярск (391)204-63-61  
Курск (4712)77-13-04  
Курган (3522)50-90-47  
Липецк (4742)52-20-81

Магнитогорск (3519)55-03-13  
Москва (495)268-04-70  
Мурманск (8152)59-64-93  
Набережные Челны (8552)20-53-41  
Нижний Новгород (831)429-08-12  
Новокузнецк (3843)20-46-81  
Ноябрьск (3496)41-32-12  
Новосибирск (383)227-86-73  
Омск (3812)21-46-40  
Орел (4862)44-53-42  
Оренбург (3532)37-68-04  
Пенза (8412)22-31-16  
Петрозаводск (8142)55-98-37  
Псков (8112)59-10-37  
Пермь (342)205-81-47

Ростов-на-Дону (863)308-18-15  
Рязань (4912)46-61-64  
Самара (846)206-03-16  
Санкт-Петербург (812)309-46-40  
Саратов (845)249-38-78  
Севастополь (8692)22-31-93  
Саранск (8342)22-96-24  
Симферополь (3652)67-13-56  
Смоленск (4812)29-41-54  
Сочи (862)225-72-31  
Ставрополь (8652)20-65-13  
Сургут (3462)77-98-35  
Сыктывкар (8212)25-95-17  
Тамбов (4752)50-40-97  
Тверь (4822)63-31-35

Тольятти (8482)63-91-07  
Томск (3822)98-41-53  
Тула (4872)33-79-87  
Тюмень (3452)66-21-18  
Ульяновск (8422)24-23-59  
Улан-Уда (3012)59-97-51  
Уфа (347)229-48-12  
Хабаровск (4212)92-98-04  
Чебоксары (8352)28-53-07  
Челябинск (351)202-03-61  
Череповец (8202)49-02-64  
Чита (3022)38-34-83  
Якутск (4112)23-90-97  
Ярославль (4852)69-52-93

Россия +7(495)268-04-70

Казахстан +7(7172)727-132

Киргизия +996(312)96-26-47

эл.почта: [fro@nt-rt.ru](mailto:fro@nt-rt.ru) || сайт: <https://far.nt-rt.ru/>