

Модульные коллекторы

Технические характеристики

По вопросам продаж и поддержки обращайтесь:

Алматы (7273)495-231
Ангарск (3955)60-70-56
Архангельск (8182)63-90-72
Астрахань (8512)99-46-04
Барнаул (3852)73-04-60
Белгород (4722)40-23-64
Благовещенск (4162)22-76-07
Брянск (4832)59-03-52
Владивосток (423)249-28-31
Владикавказ (8672)28-90-48
Владимир (4922)49-43-18
Волгоград (844)278-03-48
Вологда (8172)26-41-59
Воронеж (473)204-51-73
Екатеринбург (343)384-55-89

Иваново (4932)77-34-06
Ижевск (3412)26-03-58
Иркутск (395)279-98-46
Казань (843)206-01-48
Калининград (4012)72-03-81
Калуга (4842)92-23-67
Кемерово (3842)65-04-62
Киров (8332)68-02-04
Коломна (4966)23-41-49
Кострома (4942)77-07-48
Краснодар (861)203-40-90
Красноярск (391)204-63-61
Курск (4712)77-13-04
Курган (3522)50-90-47
Липецк (4742)52-20-81

Магнитогорск (3519)55-03-13
Москва (495)268-04-70
Мурманск (8152)59-64-93
Набережные Челны (8552)20-53-41
Нижний Новгород (831)429-08-12
Новокузнецк (3843)20-46-81
Ноябрьск (3496)41-32-12
Новосибирск (383)227-86-73
Омск (3812)21-46-40
Орел (4862)44-53-42
Оренбург (3532)37-68-04
Пенза (8412)22-31-16
Петрозаводск (8142)55-98-37
Псков (8112)59-10-37
Пермь (342)205-81-47

Ростов-на-Дону (863)308-18-15
Рязань (4912)46-61-64
Самара (846)206-03-16
Санкт-Петербург (812)309-46-40
Саратов (845)249-38-78
Севастополь (8692)22-31-93
Саранск (8342)22-96-24
Симферополь (3652)67-13-56
Смоленск (4812)29-41-54
Сочи (862)225-72-31
Ставрополь (8652)20-65-13
Сургут (3462)77-98-35
Сыктывкар (8212)25-95-17
Тамбов (4752)50-40-97
Тверь (4822)63-31-35

Тольятти (8482)63-91-07
Томск (3822)98-41-53
Тула (4872)33-79-87
Тюмень (3452)66-21-18
Ульяновск (8422)24-23-59
Улан-Удэ (3012)59-97-51
Уфа (347)229-48-12
Хабаровск (4212)92-98-04
Чебоксары (8352)28-53-07
Челябинск (351)202-03-61
Череповец (8202)49-02-64
Чита (3022)38-34-83
Якутск (4112)23-90-97
Ярославль (4852)69-52-93

Россия +7(495)268-04-70

Казахстан +7(7172)727-132

Киргизия +996(312)96-26-47

эл.почта: fro@nt-rt.ru || сайт: <https://far.nt-rt.ru/>

MALE-FEMALE MANIFOLDS



FLANGED MANIFOLDS



MANIFOLDS WITH FLOWMETERS



For the manifolds with flowmeters view the technical sheet **ST.04.03**.
For the manifolds with balancing valves view the technical sheet **ST.04.06**.

1 DESCRIPTION

FAR offers a range of 1" - 1 1/4" - 1 1/2" modular manifolds suitable for installation in heating and cooling systems, to distribute flow to radiators /fan coils or to floor, wall and ceiling, in case of underfloor heating systems.

Manifolds are also available pre-assembled, complete with flanges and equipped with connection fittings (with automatic air vent valves, temperature gauge and drain cock).

Supply manifolds

Manifolds with balancing valves

USE: Underfloor heating systems, Systems with radiators or fan coils

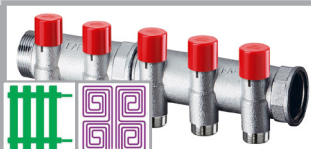

Manifolds with flowmeters and flow balancing

USE: Underfloor heating systems

Return manifolds



On the return manifolds it is possible to install the thermo-electric actuators, for the outlets opening and closing control by means of a thermostat or control unit.

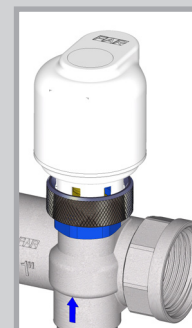

Connections types

• Manifolds with FAR 24x19 connection



Connections to the manifold can be made with:

- Multilayer pipe up to Ø20 mm
- Plastic pipe up to Ø20 mm
- Ø 10-12-14 -15-16 mm copper pipe

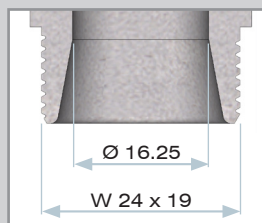

! GREATER COMPATIBILITY!

This type of outlet allows the connection of a greater range of copper, plastic and multilayer pipes compared to the standard Eurokonus connection sizes.

• Manifolds with EUROKONUS connection

It is available in 1/2" and 3/4" sizes.



Connections to the manifold can be made with:

- Multilayer pipe up to Ø21 mm
- Plastic pipe up to Ø21 mm
- Ø 15-18 mm copper pipe

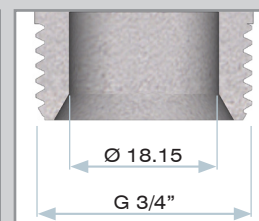
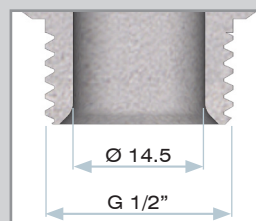

* FAR modular manifolds in 1 1/2" version are ideal for underfloor heating systems serving large surface areas with great flow rate demand. It is possible to connect Ø 25-26 mm plastic and multilayer pipes (consult the technical sheet **ST.04.02**).

2 CONSTRUCTION FEATURES

The special shape of FAR manifolds facilitates high flow rates by reducing flow resistances (Fig.1) while thanks to a simple safety system, it is possible to replace the double O-ring seal of the internal body, without any need to drain the system. (Fig.2).

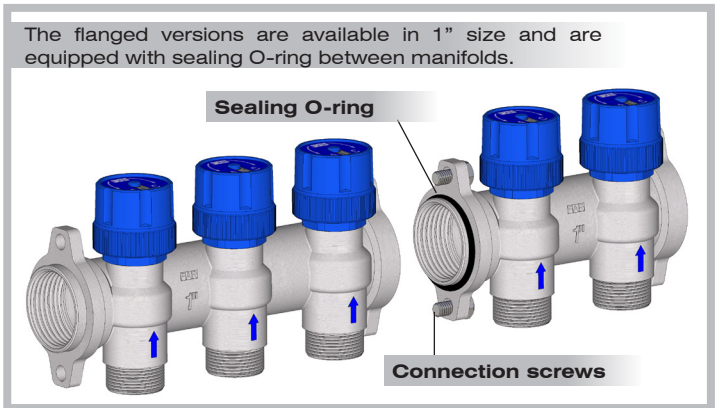
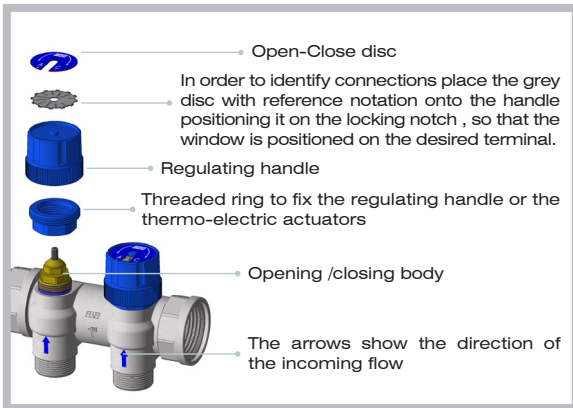
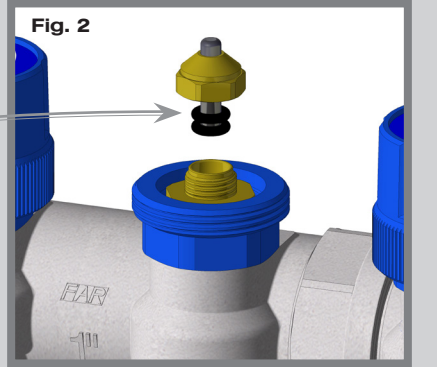
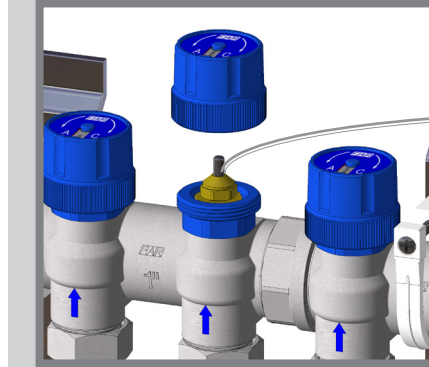
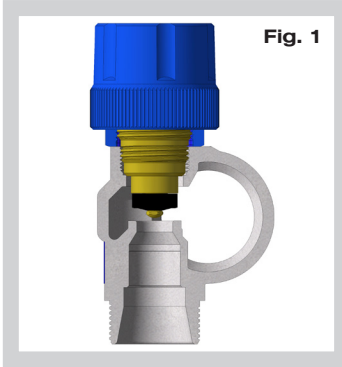

3 INSTALLATION

⚠ The Thermo-electric manifolds can be installed in any position, except when an automatic air vent valve is assembled: the valve must be placed always in a vertical position!

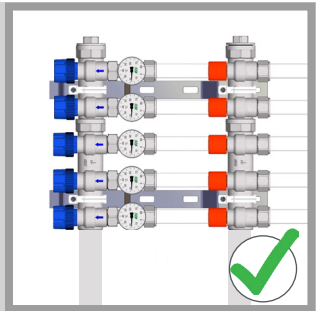
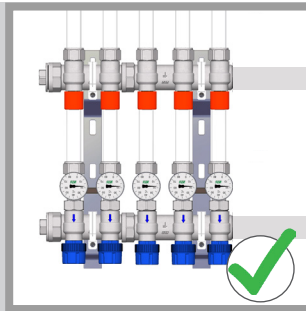
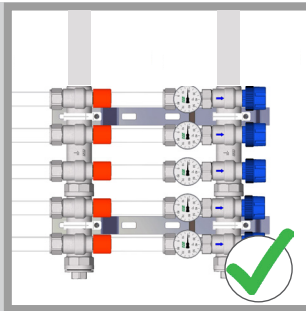
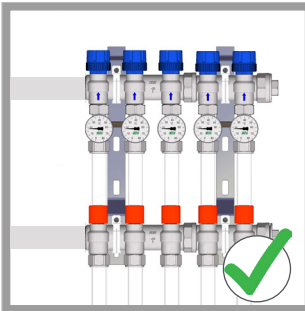

Manifolds with balancing flowmeters

To complete open and then balance the flowmeters, remove the anti-tampering device and turn the regulating valve clockwise to decrease flow, or counterclockwise to increase it.

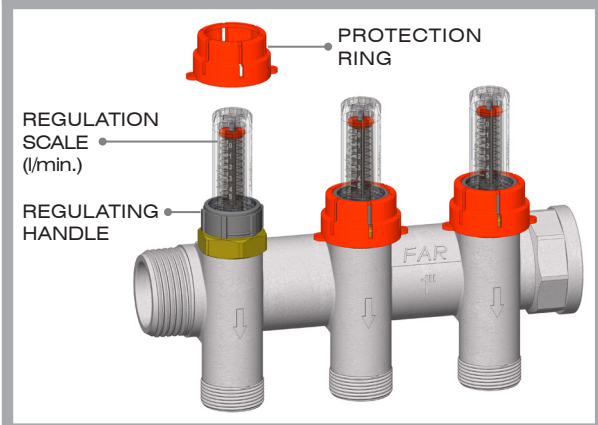

Manifolds with balancing lockshield valves

It is possible to set the flow rate value to each outlet for the circuit balancing. Remove the red cap, without any need for wrench, and then proceed with the balancing by rotating the handle.

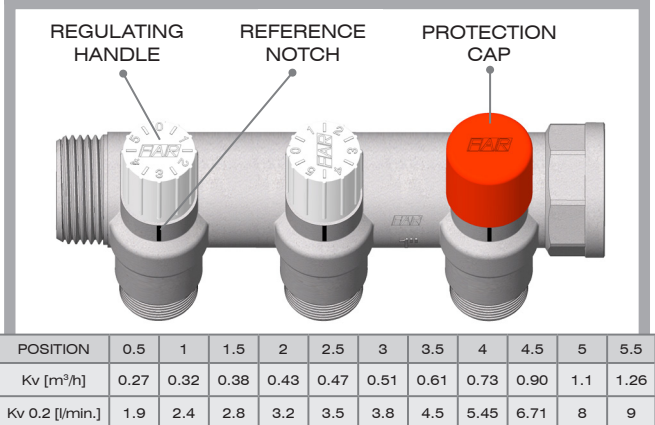

4 INSTALLATION COMPONENTS

As range completion, we offer a lot of various components and accessories to be installed, in order to meet the requirements of the most part of the heating and cooling systems.

4.1 THERMO-ELECTRIC ACTUATORS

The function of the thermo-electric actuators is the automatic opening and closing of all units to which it is interconnected in response to an electrical signal. When the thermostat or control unit - to which the thermoelectric actuator is connected - transmits a signal, the inner element is electrically heated, thus fully opening (NO) or closing (NC) the valve.

The position can be identified by means of the cylindrical position indicator on the actuator head.

- If the actuator is of the **Normally Closed (NC)** type, without an electrical supply the valve will remain shut.
- If the actuator is of the **Normally Open (NO)** type, without an electrical supply the valve will remain open.

2 wired thermoelectric actuator

CODE	VOLTAGE	TYPE	TIME
1909	24V	N.C.	180 s
1919	230V	N.C.	180 s
1929	24V	N.O.	180 s
1939	230V	N.O.	180 s

4 wired thermoelectric actuator with auxiliary micro-switch

CODE	VOLTAGE	TYPE	TIME
1913	24V	N.C.	90 s
1914	230V	N.C.	180 s
1923	24V	N.C.	90 s
1924	230V	N.C.	180 s

No adapter is required in order to install the actuator. Simply unscrew the blue handle from the manifold and then screw the actuator on the ring (**Fig.1**).

The actuator must be lightly hand-tightened. Do not use any wrenches, which could damage the actuator itself (**Fig.2**).

Open and closed positions can be easily established with the aid of a blue strip located on the indicator (**Fig.3**).

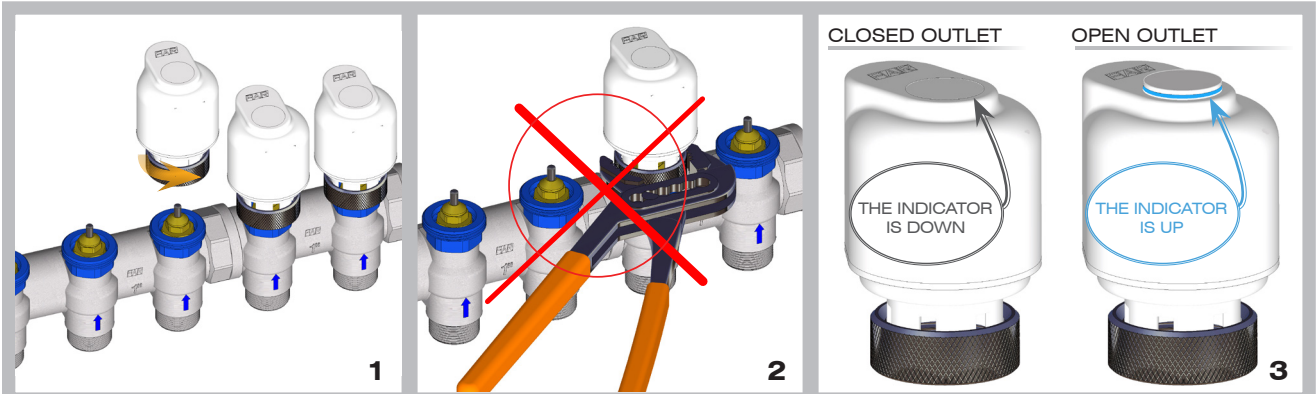

The illustration shows an example of installation for connection of some 4-wired thermo-electric actuators equipped with auxiliary micro-switch.

Parallel connection makes it possible to set up the system such that once the first actuator opens it will permit the system to switch on and once the last actuator closes, the pump or the boiler will also shut down.

The 2-wired thermo-electric actuators (Art.1909-1919-1929-1939) are not equipped with the 2 black wires of the auxiliary micro-switch.

- VA** thermo-electric actuator
- MC** micro-switch inside actuator
- TA** room thermostat

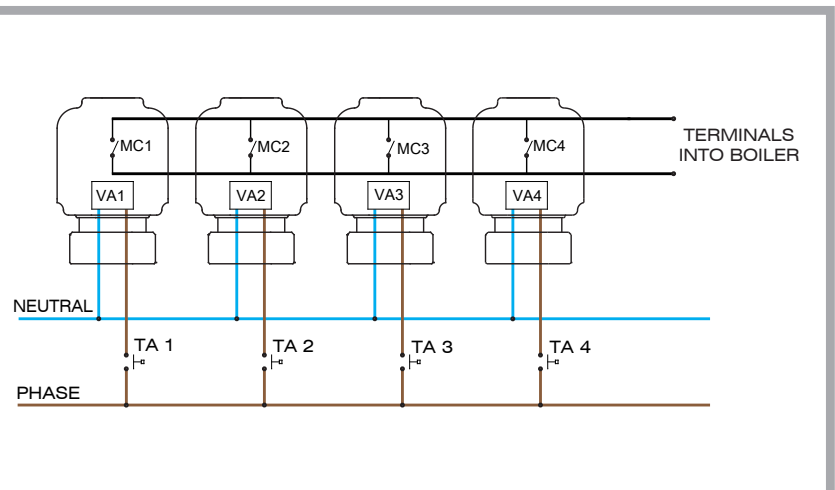

For further information about thermo-electric actuators view the technical sheet **ST.04.05**

4.2 ADAPTERS AND SEALING KIT

KIT FOR COPPER PIPE



Art. 8427

Sealing kit for copper pipe
Ø10 - Ø12 - Ø14



Art. 8429

Sealing kit for copper pipe
Ø15 - Ø16



Art. 8420

Sealing kit for copper pipe
Ø15 - EUROKONUS



Art. 8421

Sealing kit for copper pipe
Ø18 - EUROKONUS

KIT FOR MULTILAYER PIPE



Art. 6055

Kit for multilayer pipe with
interchangeable sizes



Art. 6076

Kit for multilayer pipe with
EUROKONUS connection

KIT FOR PLASTIC PIPE



Art. 6052

Kit for plastic pipe with
interchangeable sizes



Art. 6075

Kit for plastic pipe with
EUROKONUS connection

Art. 8850

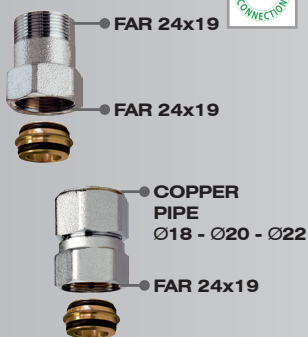

Chrome-plated straight extension
with FAR 24x19 connection.
Available extension length: 30-
35-40mm
**Available also for Ø 18-20-
22mm copper pipes**

Art. 8854



MULTILAYER
PIPE
Ø25 - Ø26
FAR 24x19
Chrome-plated straight
extension with FAR 24x19
connection for Ø25 - Ø26
multilayer pipes

Art. 8865



1/2" - 3/4"
MALE
FAR 24x19
Chrome-plated reducer
to change a FAR 24x19
connection in a 1/2" -
3/4" male thread.

Art. 8870



1/2"
FEMALE
FAR 24x19
Chrome-plated reducer
to change a FAR 24x19
connection in a 1/2"
female thread.

4.3 INSULATION

PPE pre-formed anti-condensation insulation can be used to thermally isolate manifolds.



Art. 9300

Insulation is available with 2, 3 and 4 ports for 1" size manifolds

While for 1 1/4 and 1 1/2 manifolds, insulation is available with 2 and 3 ports

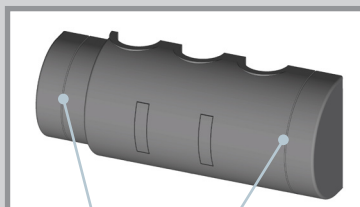

The grooves on the anticondensation
shells indicate the exact cut point in
the event to join two or more shells to
insulate the manifold.

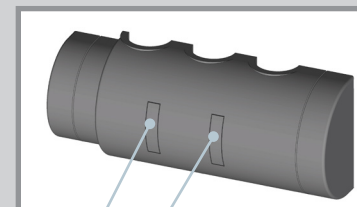

The slots to be cut out in
correspondence with the
manifold supports fixing are
marked on the rear shell.

Art. 9301

Art. 9302

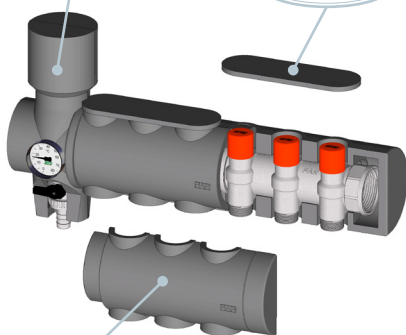

Art. 9300



Art. 9301



*Art. 9302

*to be used on supply manifolds with
balancing lockshield valve only.

4.4 INSPECTION BOXES

In order to meet the various systems requirements, FAR offers a wide range of metal inspection boxes, available in different versions and sizes.

Here below the tables show the maximum number of the recommended installable ports, considering also the installation of an intermediate connection complete with an air vent valve, a pressure gauge and a drain cock, and of a zone valve or a ball valve as well.

Art. 7148

Sheet steel box for distribution manifolds complete with painted cover

- Adjustable depth from 110 mm to 150 mm



BOX WIDTH - COMPONENTS TO INSTALL

- 400 mm** 4 port manifold + valve + connection + plug
- 500 mm** 6 port manifold + valve + connection + plug
- 600 mm** 7 port manifold + valve + connection + plug
- 800 mm** 10 port manifold + valve + connection + plug
- 1000 mm** 12 port manifold + valve + connection + plug
- 1200 mm** 14 port manifold + valve + connection + plug

Art.7150

Painted sheet steel complete with cover for distribution manifolds

- Adjustable depth from 110 mm to 150 mm



BOX WIDTH - COMPONENTS TO INSTALL

- 400 mm** 4 port manifold + valve + connection + plug
- 500 mm** 6 port manifold + valve + connection + plug
- 600 mm** 7 port manifold + valve + connection + plug
- 800 mm** 10 port manifold + valve + connection + plug
- 1000 mm** 12 port manifold + valve + connection + plug
- 1200 mm** 14 port manifold + valve + connection + plug

Art.7158

Sheet steel box with painted cover and built-in feet for distribution manifolds

- Adjustable depth from 80 mm to 120 mm



BOX WIDTH - COMPONENTS TO INSTALL

- 600 mm** 7 port manifold + valve + connection + plug
- 850 mm** 10 port manifold + valve + connection + plug

Art.7165

Painted sheet steel box complete with cover for distribution manifolds. Built-in feet.

- Adjustable depth from 150 mm to 190 mm



BOX WIDTH - COMPONENTS TO INSTALL

- 700 mm** 9 port manifold + valve + connection + plug
- 800 mm** 10 port manifold + valve + connection + plug
- 900 mm** 11 port manifold + valve + connection + plug
- 1000 mm** 12 port manifold + valve + connection + plug
- 1100 mm** 13 port manifold + valve + connection + plug
- 1200 mm** 14 port manifold + valve + connection + plug

The thermo-electric manifolds can be installed in the Inspection plastic boxes 'TUTTO' as well.

- **art.7410 50** with 500x410x100 sizes*
- **art.7410 70** with 700x410x100 sizes*
- **art.7410 90** with 900x410x100 sizes*

*Sizes in mm

For further details consult the Technical Sheet of metal inspection boxes, **ST.06.01.** or of the plastic inspection boxes, **ST.06.02.**

4.5 BY-PASS KIT

During operation one or more lines may be closed, i.e. in those areas in which there is no demand for heat transfer fluid. In this case there will be an increase in the resistance from these circuits and, therefore, the pump will work harder. In order to avoid this, a by-pass kit with built-in differential pressure valve is available for connection to the manifolds. Once a pre-set pressure level is reached this valve ensures discharge of excess flow on the return manifold allowing the pump to maintain a virtually constant speed.

Art.3423



Installation overview

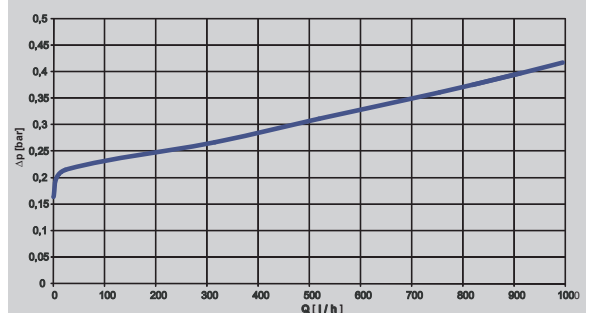
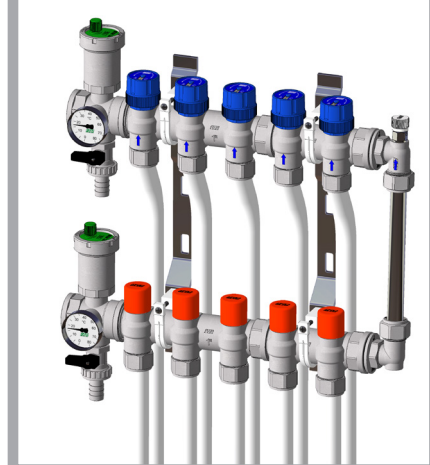

Typical differential pressure of by-pass kit

The above diagram shows pattern of flow passing from a differential by-pass valve, depending on upstream pressure. Opening is set at about 0,2 bar and, at this point, excess flow is sent back to the boiler.

Art.3422



4.6 TEMPERATURE GAUGE FITTING

Art.3433 - 3434



Regulating the flow via micrometric lockshield valves on the supply manifold, it is possible to increase or decrease the circulating flow rate and thus the return temperature of each circuit can also be regulated to the design value. By installing a temperature gauge fitting on each return circuit, temperatures can be controlled and regulated by means of the lockshield valves.

To the bottom of temperature gauge fitting can be connected:

- copper pipes up to 16mm
- plastic and multilayer pipes up to 20mm
- **Art.3433** with **3/4" EUROKONUS** connection
- **Art.3434** with **FAR 24x19** connection

Technical features

Temperature range: 0-80°C
 Max working pressure: 10 bar
 Body material: CW617N
 Temperature gauge housing: zinc-coated steel
 Accuracy rating: 2,5

Installation overview

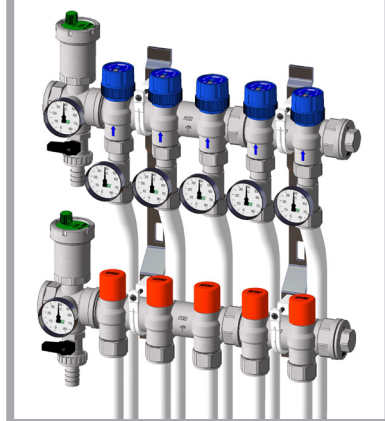

4.7 FLOWMETER

Art.3428 - 3429



Installed on each outlet of the return manifold, the flowmeter allows to check the exact flow rate (l/min) of each circuit. They are available with scale from 1 to 3,5 l/min or from 2 to 8 l/min depending on system requirements.

To the bottom of temperature gauge fitting can be connected:

- copper pipes up to 16mm
- plastic and multilayer pipes up to 20mm
- **Art.3428** with **3/4" EUROKONUS** connection
- **Art.3429** with **FAR 24x19** connection

Technical features

Working temperature: 95°C
 Max working pressure: 10 bar
 Scale: 1-3,5 2-8 l/min
 Accuracy: ±10%
 Body material: CW617N

Technical Sheet of the flowmeters: **ST.04.07**

Installation overview



4.8 FITTING WITH DOUBLE CONNECTION

Art.3424



The fitting allows to double one or more manifold outlets.

The fitting is equipped with a swiveling nut with a 24x19 female thread to connect to the manifold outlets and with two male 24x19 connections.

NB: It is recommended to use with a pipe maximum diameter of Ø 14mm, as the flow rate of a manifold outlet is divided in two flow rates.

Technical features

Working temperature: 95°C
 Max working pressure: 10 bar
 Body material: CW617N
 O-ring: EPDM-P

Installation overview

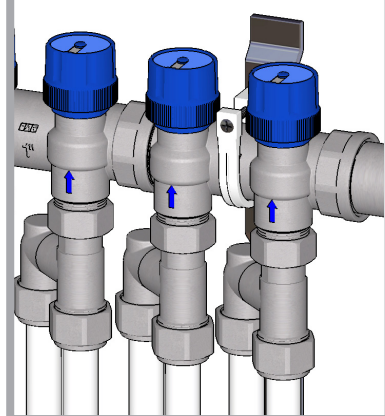

5 FLUID DYNAMICS FEATURES

RETURN MANIFOLDS

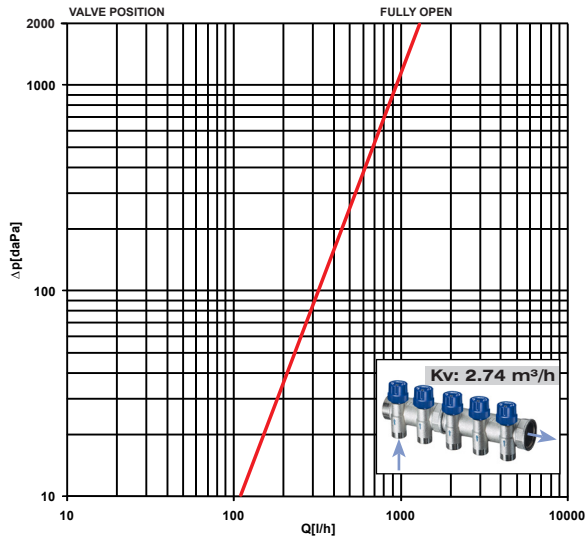

MANIFOLDS WITH FLOWMETERS

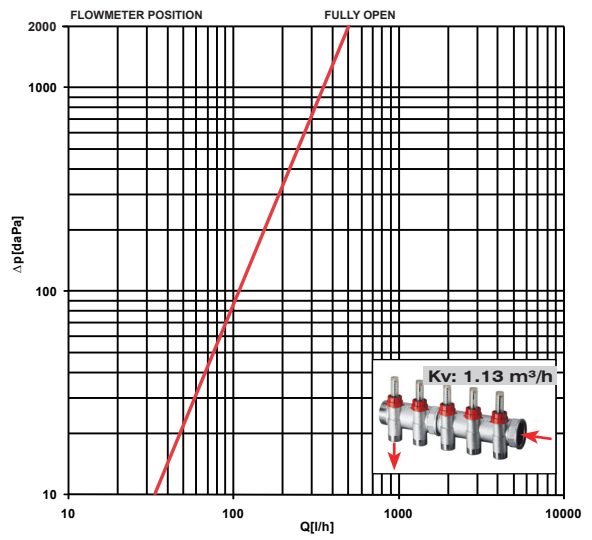

MANIFOLDS WITH BALANCING LOCKSHIELD VALVES

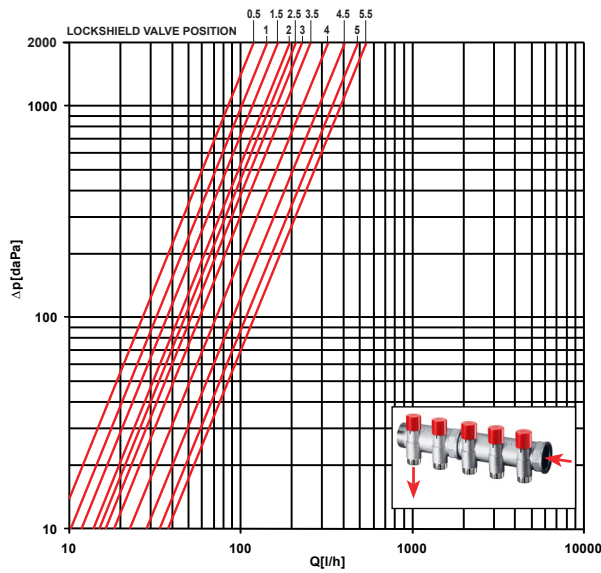

The table shows the flow rate values according to the position of the balancing lockshield valve

Position	0.5	1	1.5	2	2.5	3	3.5	4	4.5	5	5.5
Kv [m³/h]	0.27	0.32	0.38	0.43	0.47	0.51	0.61	0.73	0.9	1.1	1.26

6 DIMENSIONAL FEATURES

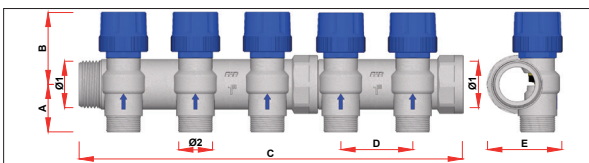

ART. 3913-3911

CODE	PORTS	Ø1	A	B	C	D	E	Ø2
3913-3911	2	G1	34	52	116	50	52	24x19-G1/2-G3/4
3913-3911	3	G1	34	52	166	50	52	24x19-G1/2-G3/4
3913-3911	4	G1	34	52	216	50	52	24x19-G1/2-G3/4
3913-3911	5	G1	34	52	267	50	52	24x19-G1/2-G3/4
3913-3911	6	G1	34	52	317	50	52	24x19-G1/2-G3/4
3913-3911	7	G1	34	52	367	50	52	24x19-G1/2-G3/4
3913-3911	8	G1	34	52	417	50	52	24x19-G1/2-G3/4
3913-3911	9	G1	34	52	468	50	52	24x19-G1/2-G3/4
3913-3911	10	G1	34	52	518	50	52	24x19-G1/2-G3/4
3913-3911	11	G1	34	52	568	50	52	24x19-G1/2-G3/4
3913-3911	12	G1	34	52	618	50	52	24x19-G1/2-G3/4
3913-3911	2	G1 1/4	38	56	120	50	62	24x19-G3/4
3913-3911	3	G1 1/4	38	56	170	50	62	24x19-G3/4
3913-3911	4	G1 1/4	38	56	221	50	62	24x19-G3/4
3913-3911	5	G1 1/4	38	56	271	50	62	24x19-G3/4
3913-3911	6	G1 1/4	38	56	321	50	62	24x19-G3/4
3913-3911	7	G1 1/4	38	56	372	50	62	24x19-G3/4
3913-3911	8	G1 1/4	38	56	422	50	62	24x19-G3/4
3913-3911	9	G1 1/4	38	56	472	50	62	24x19-G3/4
3913-3911	10	G1 1/4	38	56	523	50	62	24x19-G3/4
3913-3911	11	G1 1/4	38	56	573	50	62	24x19-G3/4
3913-3911	12	G1 1/4	38	56	623	50	62	24x19-G3/4

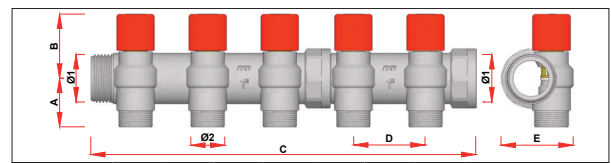

ART. 3923-3921

CODE	PORTS	Ø1	A	B	C	D	E	Ø2
3923-3921	2	G1	34	45	116	50	50	24x19-G1/2-G3/4
3923-3921	3	G1	34	45	166	50	50	24x19-G1/2-G3/4
3923-3921	4	G1	34	45	216	50	50	24x19-G1/2-G3/4
3923-3921	5	G1	34	45	267	50	50	24x19-G1/2-G3/4
3923-3921	6	G1	34	45	317	50	50	24x19-G1/2-G3/4
3923-3921	7	G1	34	45	367	50	50	24x19-G1/2-G3/4
3923-3921	8	G1	34	45	417	50	50	24x19-G1/2-G3/4
3923-3921	9	G1	34	45	468	50	50	24x19-G1/2-G3/4
3923-3921	10	G1	34	45	518	50	50	24x19-G1/2-G3/4
3923-3921	11	G1	34	45	568	50	50	24x19-G1/2-G3/4
3923-3921	12	G1	34	45	618	50	50	24x19-G1/2-G3/4
3923-3921	2	G1 1/4	38	50	120	50	60	24x19-G3/4
3923-3921	3	G1 1/4	38	50	170	50	60	24x19-G3/4
3923-3921	4	G1 1/4	38	50	221	50	60	24x19-G3/4
3923-3921	5	G1 1/4	38	50	271	50	60	24x19-G3/4
3923-3921	6	G1 1/4	38	50	321	50	60	24x19-G3/4
3923-3921	7	G1 1/4	38	50	372	50	60	24x19-G3/4
3923-3921	8	G1 1/4	38	50	422	50	60	24x19-G3/4
3923-3921	9	G1 1/4	38	50	472	50	60	24x19-G3/4
3923-3921	10	G1 1/4	38	50	523	50	60	24x19-G3/4
3923-3921	11	G1 1/4	38	50	573	50	60	24x19-G3/4
3923-3921	12	G1 1/4	38	50	623	50	60	24x19-G3/4

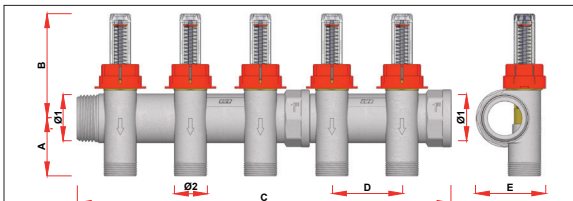

ART. 3970-3980

CODE	PORTS	Ø1	A	B	C	D	E	Ø2
3970-3980	2	G1	41	75	116	50	50	24x19-G1/2-G3/4
3970-3980	3	G1	41	75	166	50	50	24x19-G1/2-G3/4
3970-3980	4	G1	41	75	216	50	50	24x19-G1/2-G3/4
3970-3980	5	G1	41	75	267	50	50	24x19-G1/2-G3/4
3970-3980	6	G1	41	75	317	50	50	24x19-G1/2-G3/4
3970-3980	7	G1	41	75	367	50	50	24x19-G1/2-G3/4
3970-3980	8	G1	41	75	417	50	50	24x19-G1/2-G3/4
3970-3980	9	G1	41	75	468	50	50	24x19-G1/2-G3/4
3970-3980	10	G1	41	75	518	50	50	24x19-G1/2-G3/4
3970-3980	11	G1	41	75	568	50	50	24x19-G1/2-G3/4
3970-3980	12	G1	41	75	618	50	50	24x19-G1/2-G3/4
3970-3980	2	G1 1/4	39	78	120	50	60	24x19-G3/4
3970-3980	3	G1 1/4	39	78	170	50	60	24x19-G3/4
3970-3980	4	G1 1/4	39	78	221	50	60	24x19-G3/4
3970-3980	5	G1 1/4	39	78	271	50	60	24x19-G3/4
3970-3980	6	G1 1/4	39	78	321	50	60	24x19-G3/4
3970-3980	7	G1 1/4	39	78	372	50	60	24x19-G3/4
3970-3980	8	G1 1/4	39	78	422	50	60	24x19-G3/4
3970-3980	9	G1 1/4	39	78	472	50	60	24x19-G3/4
3970-3980	10	G1 1/4	39	78	523	50	60	24x19-G3/4
3970-3980	11	G1 1/4	39	78	573	50	60	24x19-G3/4
3970-3980	12	G1 1/4	39	78	623	50	60	24x19-G3/4

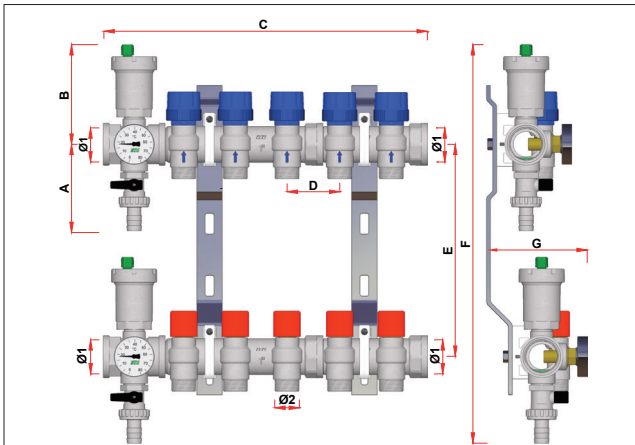

ART. 3462-3468

CODE	PORTS	Ø1	A	B	C	D	E	F	G	Ø2
3462-3468	2	G1	84	97	163	50	206-235	387-416	96	24x19-G1/2-G3/4
3462-3468	3	G1	84	97	213	50	206-235	387-416	96	24x19-G1/2-G3/4
3462-3468	4	G1	84	97	263	50	206-235	387-416	96	24x19-G1/2-G3/4
3462-3468	5	G1	84	97	314	50	206-235	387-416	96	24x19-G1/2-G3/4
3462-3468	6	G1	84	97	364	50	206-235	387-416	96	24x19-G1/2-G3/4
3462-3468	7	G1	84	97	414	50	206-235	387-416	96	24x19-G1/2-G3/4
3462-3468	8	G1	84	97	464	50	206-235	387-416	96	24x19-G1/2-G3/4
3462-3468	9	G1	84	97	515	50	206-235	387-416	96	24x19-G1/2-G3/4
3462-3468	10	G1	84	97	565	50	206-235	387-416	96	24x19-G1/2-G3/4
3462-3468	11	G1	84	97	615	50	206-235	387-416	96	24x19-G1/2-G3/4
3462-3468	12	G1	84	97	665	50	206-235	387-416	96	24x19-G1/2-G3/4
3462-3468	2	G1 1/4	90	102	167	50	206-235	398-427	107	24x19-G3/4
3462-3468	3	G1 1/4	90	102	217	50	206-235	398-427	107	24x19-G3/4
3462-3468	4	G1 1/4	90	102	268	50	206-235	398-427	107	24x19-G3/4
3462-3468	5	G1 1/4	90	102	318	50	206-235	398-427	107	24x19-G3/4
3462-3468	6	G1 1/4	90	102	368	50	206-235	398-427	107	24x19-G3/4
3462-3468	7	G1 1/4	90	102	419	50	206-235	398-427	107	24x19-G3/4
3462-3468	8	G1 1/4	90	102	469	50	206-235	398-427	107	24x19-G3/4
3462-3468	9	G1 1/4	90	102	519	50	206-235	398-427	107	24x19-G3/4
3462-3468	10	G1 1/4	90	102	570	50	206-235	398-427	107	24x19-G3/4
3462-3468	11	G1 1/4	90	102	620	50	206-235	398-427	107	24x19-G3/4
3462-3468	12	G1 1/4	90	102	670	50	206-235	398-427	107	24x19-G3/4

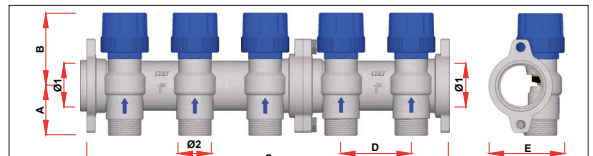

ART. 3914-3917

CODE	PORTS	Ø1	A	B	C	D	E	Ø2
3914-3917	2	G1	35	52	104	50	54	24x19-G3/4
3914-3917	3	G1	35	52	154	50	54	24x19-G3/4
3914-3917	4	G1	35	52	204	50	54	24x19-G3/4
3914-3917	5	G1	35	52	258	50	54	24x19-G3/4
3914-3917	6	G1	35	52	308	50	54	24x19-G3/4
3914-3917	7	G1	35	52	358	50	54	24x19-G3/4
3914-3917	8	G1	35	52	408	50	54	24x19-G3/4
3914-3917	9	G1	35	52	462	50	54	24x19-G3/4
3914-3917	10	G1	35	52	512	50	54	24x19-G3/4
3914-3917	11	G1	35	52	562	50	54	24x19-G3/4
3914-3917	12	G1	35	52	612	50	54	24x19-G3/4

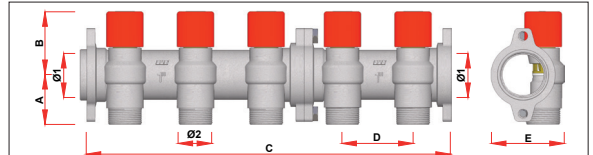

ART. 3915-3918

CODE	PORTS	Ø1	A	B	C	D	E	Ø2
3915-3918	2	G1	35	45	104	50	52	24x19-G3/4
3915-3918	3	G1	35	45	154	50	52	24x19-G3/4
3915-3918	4	G1	35	45	204	50	52	24x19-G3/4
3915-3918	5	G1	35	45	258	50	52	24x19-G3/4
3915-3918	6	G1	35	45	308	50	52	24x19-G3/4
3915-3918	7	G1	35	45	358	50	52	24x19-G3/4
3915-3918	8	G1	35	45	408	50	52	24x19-G3/4
3915-3918	9	G1	35	45	462	50	52	24x19-G3/4
3915-3918	10	G1	35	45	512	50	52	24x19-G3/4
3915-3918	11	G1	35	45	562	50	52	24x19-G3/4
3915-3918	12	G1	35	45	612	50	52	24x19-G3/4

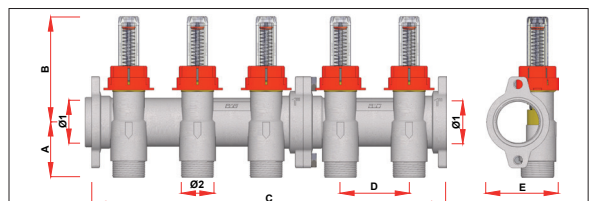

ART. 3972-3982

CODE	PORTS	Ø1	A	B	C	D	E	Ø2
3972-3982	2	G1	40	76	104	50	52	24x19-G3/4
3972-3982	3	G1	40	76	154	50	52	24x19-G3/4
3972-3982	4	G1	40	76	204	50	52	24x19-G3/4
3972-3982	5	G1	40	76	258	50	52	24x19-G3/4
3972-3982	6	G1	40	76	308	50	52	24x19-G3/4
3972-3982	7	G1	40	76	358	50	52	24x19-G3/4
3972-3982	8	G1	40	76	408	50	52	24x19-G3/4
3972-3982	9	G1	40	76	462	50	52	24x19-G3/4
3972-3982	10	G1	40	76	512	50	52	24x19-G3/4
3972-3982	11	G1	40	76	562	50	52	24x19-G3/4
3972-3982	12	G1	40	76	612	50	52	24x19-G3/4

TECHNICAL FEATURES

Production materials

- Manifold: CB753S brass
- Internal body: CW614N brass
- O-ring: EPDM
- Handle and ring: ABS

Technical features

- Nominal pressure: 10 bar
- Working temperature range: 5-95°C
- Compatible media: water, water with glycol

NB: The above features are valid for return manifolds with valves

For the technical features of manifolds with flowmeters consult the Technical Sheet **ST.04.03**

For the technical features of manifolds with balancing lockshield valves consult the Technical Sheet **ST.04.06**

По вопросам продаж и поддержки обращайтесь:

Алматы (7273)495-231
Ангарск (3955)60-70-56
Архангельск (8182)63-90-72
Астрахань (8512)99-46-04
Барнаул (3852)73-04-60
Белгород (4722)40-23-64
Благовещенск (4162)22-76-07
Брянск (4832)59-03-52
Владивосток (423)249-28-31
Владикавказ (8672)28-90-48
Владимир (4922)49-43-18
Волгоград (844)278-03-48
Вологда (8172)26-41-59
Воронеж (473)204-51-73
Екатеринбург (343)384-55-89

Иваново (4932)77-34-06
Ижевск (3412)26-03-58
Иркутск (395)279-98-46
Казань (843)206-01-48
Калининград (4012)72-03-81
Калуга (4842)92-23-67
Кемерово (3842)65-04-62
Киров (8332)68-02-04
Коломна (4966)23-41-49
Кострома (4942)77-07-48
Краснодар (861)203-40-90
Красноярск (391)204-63-61
Курск (4712)77-13-04
Курган (3522)50-90-47
Липецк (4742)52-20-81

Магнитогорск (3519)55-03-13
Москва (495)268-04-70
Мурманск (8152)59-64-93
Набережные Челны (8552)20-53-41
Нижний Новгород (831)429-08-12
Новокузнецк (3843)20-46-81
Ноябрьск (3496)41-32-12
Новосибирск (383)227-86-73
Омск (3812)21-46-40
Орел (4862)44-53-42
Оренбург (3532)37-68-04
Пенза (8412)22-31-16
Петрозаводск (8142)55-98-37
Псков (8112)59-10-37
Пермь (342)205-81-47

Ростов-на-Дону (863)308-18-15
Рязань (4912)46-61-64
Самара (846)206-03-16
Санкт-Петербург (812)309-46-40
Саратов (845)249-38-78
Севастополь (8692)22-31-93
Саранск (8342)22-96-24
Симферополь (3652)67-13-56
Смоленск (4812)29-41-54
Сочи (862)225-72-31
Ставрополь (8652)20-65-13
Сургут (3462)77-98-35
Сыктывкар (8212)25-95-17
Тамбов (4752)50-40-97
Тверь (4822)63-31-35

Тольятти (8482)63-91-07
Томск (3822)98-41-53
Тула (4872)33-79-87
Тюмень (3452)66-21-18
Ульяновск (8422)24-23-59
Улан-Уда (3012)59-97-51
Уфа (347)229-48-12
Хабаровск (4212)92-98-04
Чебоксары (8352)28-53-07
Челябинск (351)202-03-61
Череповец (8202)49-02-64
Чита (3022)38-34-83
Якутск (4112)23-90-97
Ярославль (4852)69-52-93

Россия +7(495)268-04-70

Казахстан +7(7172)727-132

Киргизия +996(312)96-26-47

эл.почта: fro@nt-rt.ru || сайт: <https://far.nt-rt.ru/>