

# Коллекторы модульные, подающие, с запорными вентилями МР 3923, 3461

## Технические характеристики

По вопросам продаж и поддержки обращайтесь:

Алматы (7273)495-231  
Ангарск (3955)60-70-56  
Архангельск (8182)63-90-72  
Астрахань (8512)99-46-04  
Барнаул (3852)73-04-60  
Белгород (4722)40-23-64  
Благовещенск (4162)22-76-07  
Брянск (4832)59-03-52  
Владивосток (423)249-28-31  
Владикавказ (8672)28-90-48  
Владимир (4922)49-43-18  
Волгоград (844)278-03-48  
Вологда (8172)26-41-59  
Воронеж (473)204-51-73  
Екатеринбург (343)384-55-89

Иваново (4932)77-34-06  
Ижевск (3412)26-03-58  
Иркутск (395)279-98-46  
Казань (843)206-01-48  
Калининград (4012)72-03-81  
Калуга (4842)92-23-67  
Кемерово (3842)65-04-62  
Киров (8332)68-02-04  
Коломна (4966)23-41-49  
Кострома (4942)77-07-48  
Краснодар (861)203-40-90  
Красноярск (391)204-63-61  
Курск (4712)77-13-04  
Курган (3522)50-90-47  
Липецк (4742)52-20-81

Магнитогорск (3519)55-03-13  
Москва (495)268-04-70  
Мурманск (8152)59-64-93  
Набережные Челны (8552)20-53-41  
Нижний Новгород (831)429-08-12  
Новокузнецк (3843)20-46-81  
Ноябрьск (3496)41-32-12  
Новосибирск (383)227-86-73  
Омск (3812)21-46-40  
Орел (4862)44-53-42  
Оренбург (3532)37-68-04  
Пенза (8412)22-31-16  
Петрозаводск (8142)55-98-37  
Псков (8112)59-10-37  
Пермь (342)205-81-47

Ростов-на-Дону (863)308-18-15  
Рязань (4912)46-61-64  
Самара (846)206-03-16  
Санкт-Петербург (812)309-46-40  
Саратов (845)249-38-78  
Севастополь (8692)22-31-93  
Саранск (8342)22-96-24  
Симферополь (3652)67-13-56  
Смоленск (4812)29-41-54  
Сочи (862)225-72-31  
Ставрополь (8652)20-65-13  
Сургут (3462)77-98-35  
Сыктывкар (8212)25-95-17  
Тамбов (4752)50-40-97  
Тверь (4822)63-31-35

Тольятти (8482)63-91-07  
Томск (3822)98-41-53  
Тула (4872)33-79-87  
Тюмень (3452)66-21-18  
Ульяновск (8422)24-23-59  
Улан-Удэ (3012)59-97-51  
Уфа (347)229-48-12  
Хабаровск (4212)92-98-04  
Чебоксары (8352)28-53-07  
Челябинск (351)202-03-61  
Череповец (8202)49-02-64  
Чита (3022)38-34-83  
Якутск (4112)23-90-97  
Ярославль (4852)69-52-93

Россия +7(495)268-04-70

Казахстан +7(7172)727-132

Киргизия +996(312)96-26-47

эл.почта: [fro@nt-rt.ru](mailto:fro@nt-rt.ru) || сайт: <https://far.nt-rt.ru/>

## BALANCING THERMO-ELECTRIC MANIFOLDS



Art. 3923

Chrome-plated modular manifold with balancing lockshield valves. Suitable for heating systems.

- Interchangeable sizes for copper, plastic and multilayer pipes
- Side connections: 1" - 1"1/4 male-female
- Centre line between ports: 50 mm

Also available in flanged version, Art.3915

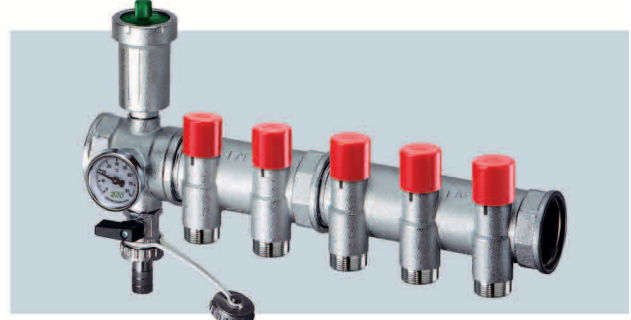

Art. 3461

Chrome-plated modular flanged manifold with balancing lockshield valves and intermediate connection.

- Interchangeable sizes for copper, plastic and multilayer pipes
- Side connections: 1" - 1"1/4 male-female
- Centre line between ports: 50 mm

• Intermediate connection complete with: air vent valve, temperature gauge and drain cock

Also available in flanged version, Art.3464

### 1. DESCRIPTION

The new manifolds with balancing bodies allow quick adjustment of the desired flow into the different circuits using the numbered settings on the handle. This particular system permits regulation with no need for special tools, in even the most confined spaces.

Once the lockshield valve is set, it is possible to assemble onto the handle a protective cap, which protects from eventual tampering made by not qualified persons.

### 2. CONSTRUCTION FEATURES

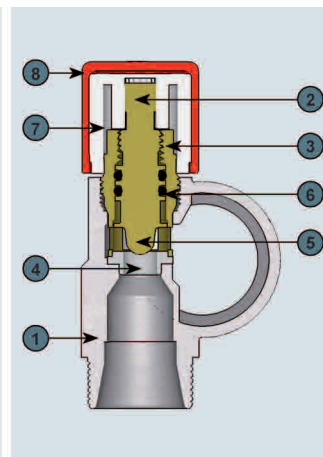
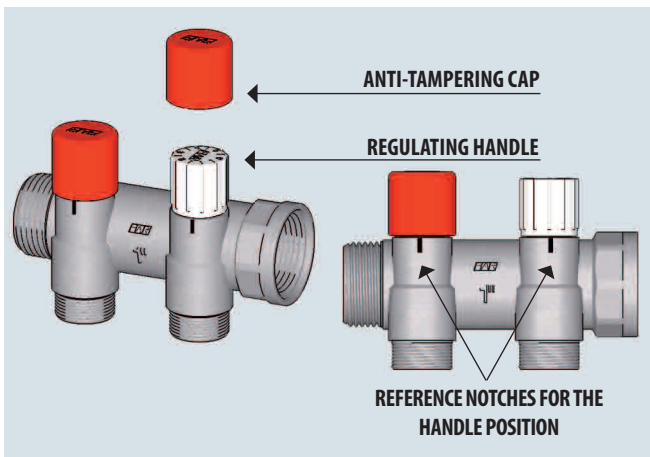

#### 1 - Manifold body:

CB753S brass

#### 2 - Stem:

CW617N brass

#### 3 - Body:

CW617N brass

#### 4 - Body seat:

P.T.F.E.

#### 5 - Shutter:

CW617N brass

#### 6 - Sealing O-ring:

EPDM

#### 7 - Regulation handle:

ABS

#### 8 - Anti-tampering cap:

ABS

Regulation is carried out by means of the numbered handle. The handle stroke is less than 360° and it ranges between 0 (lockshield valve fully closed) and 5.5 (lockshield valve fully open). The handle position can be easily identified thanks to the reference notches onto the manifold.

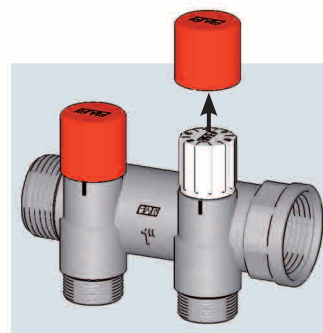
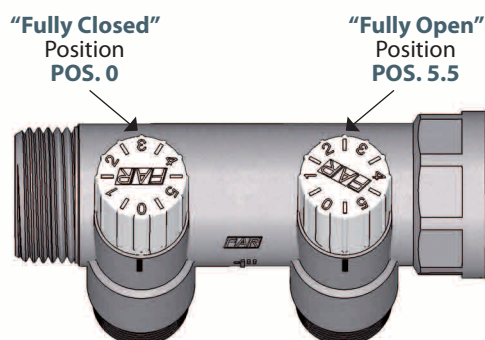

To make the assembly tamper-proof, simply press the protective device onto the regulating handle.

The red cap then rotates freely, giving protection from interference.

## 3. INSTALLATION

Installation of balancing manifolds combined with manifolds with built-in valves must take account of flow direction, as indicated below.

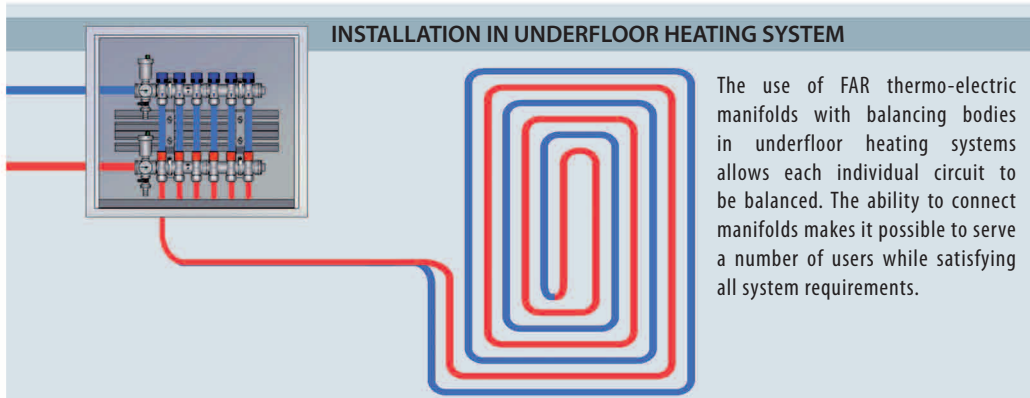
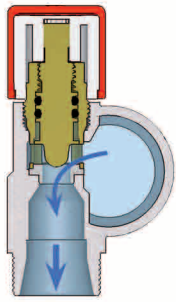

The use of FAR thermo-electric manifolds with balancing bodies in underfloor heating systems allows each individual circuit to be balanced. The ability to connect manifolds makes it possible to serve a number of users while satisfying all system requirements.

## 4. ADAPTERS FOR MANIFOLDS WITH FAR 24X19 CONNECTION



### Adapters for copper pipe:

Art. 8427



Sealing kit for Ø10 - Ø12 - Ø14 copper pipe

Art. 8429



Sealing kit for Ø 15- Ø 16 copper pipe

The sealing kit for copper pipe comprises a reducer (Ø10-12-14-15-16), a rubber compression single-taper (Ø10-12-14-15-16) and a brass guide ring (Ø10-12-14)

MATERIALS
Ring and adapter: CW614N
Single-taper: heat-resistant rubber
Nut: CW617N

TECHNICAL FEATURES
Working temperature range: 0-95°C
Max. working pressure: 10 bar

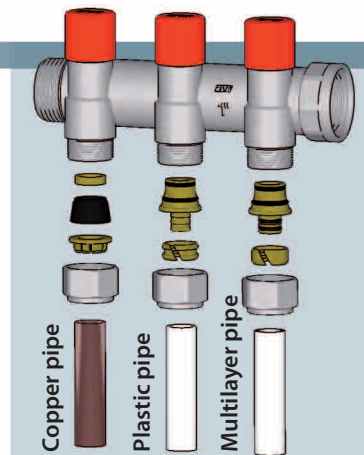

### TO ASSEMBLE THE SEALING KIT, PROCEED AS FOLLOWS:

- Insert the nut onto the pipe.
- Insert the ring onto the pipe.
- Insert the single-taper and the optional guide ring (this last one only for Ø10-12-14 pipe) onto the pipe
- Locate the pipe complete with kit in the conical seat.
- Tighten the nut.

**NOTE:** For copper pipe, sealing is guaranteed with a pipe thickness of at least 1 mm. In the event that the pipe thickness is less than 1 mm (0.5÷0.7 mm), a metal reinforcement will be required. It is important to tighten the nut firmly in order to block the pipe with the ring securely. Minimum torque wrench setting is 40Nm.

### Adapters for plastic and multilayer pipes:

Art. 6052



Kit for plastic pipes with interchangeable connection

Art. 6055



Kit for multilayer pipes with interchangeable connection

Sealing of plastic and multilayer pipe is achieved by means of a nut, an adapter and a brass ring

MATERIALS
Ring and adapter: CW614N-CW617N
O-Ring: EPDM
Nut: CW617N

TECHNICAL FEATURES
Working temperature range: 0-95°C
Max. working pressure: 10 bar

### TO ASSEMBLE THE SEALING KIT, PROCEED AS FOLLOWS:

- Insert the nut onto the pipe
- Insert the ring onto the pipe
- In case of multilayer adapters, calibrate the pipe by means of appropriate tools or a round bar, so as to protect O-rings from damages. Then insert the adapter.
- Locate the pipe complete with kit in the conical seat
- Tighten the nut

**Do NOT use grease to oil the fitting**

**NOTE:** It is important to tighten the nut firmly in order to block the pipe with the ring securely. Minimum torque wrench setting is 40Nm.

## 5. ADAPTERS FOR MANIFOLDS WITH EUROKONUS CONNECTIONS

Art. 6075



Adapters for plastic pipes

Art. 6076



Adapters for multilayer pipes

Sealing of plastic and multilayer pipe is achieved by means of a nut, an adapter and a brass ring

MATERIALS
Ring and adapter: CW614N-CW617N
O-Ring: EPDM
Nut: CW617N

TECHNICAL FEATURES
Working temperature range: 0-95°C
Max.working pressure: 10 bar

TO ASSEMBLE THE SEALING KIT, PROCEED AS FOLLOWS:

- Insert the nut onto the pipe
- Insert the ring onto the pipe
- In case of multilayer adapters, calibrate the pipe by means of appropriate tools or a round bar, so as to protect O-rings from damages. Then insert the adapter.
- Locate the pipe complete with kit in the conical seat
- Tighten the nut

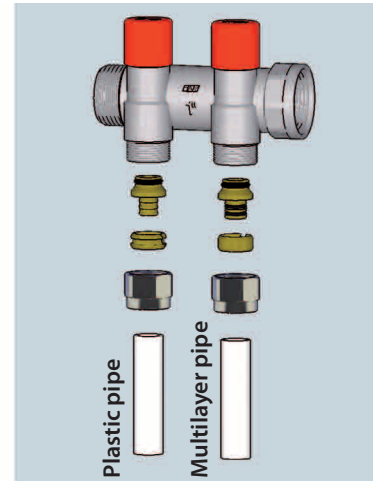

**Do NOT use grease to oil the fitting**

**NOTE:** It is important to tighten the nut firmly in order to block the pipe with the ring securely. Minimum torque wrench setting is 40Nm.

## 6. PRODUCT RANGE

Art.3916

Pre-assembled flanged manifold complete with:

- Supply balancing manifold
- Return manifold with shut-off valves suitable for thermo-electric actuators
- Fixing brackets, art.7480

Art.3929

Pre-assembled M-F manifold complete with:

- Supply balancing manifold
- Return manifold with shut-off valves suitable for thermo-electric actuators
- Fixing brackets, art.7480

Art.3462

Pre-assembled F-F manifold complete with:

- Supply balancing manifold
- Return manifold with shut-off valves suitable for thermo-electric actuators
- Intermediate connection, art.3438
- Fixing brackets, art.7480

Art.3465

Pre-assembled flanged manifold complete with:

- Supply balancing manifold
- Return manifold with shut-off valves suitable for thermo-electric actuators
- Intermediate connection, art.3445
- Fixing brackets, art.7480

Art.3477

Pre-assembled unit for underfloor heating systems complete with:

- Fix point regulating unit
- High temperature distribution manifolds
- Fixing brackets, art.7480
- Safety thermostat

Art.3491

Pre-assembled unit for underfloor heating systems complete with:

- Mixing valve with 3-point actuator
- High temperature distribution manifolds
- Fixing brackets, art.7480
- Safety thermostat

Art.3481

Pre-assembled unit for underfloor heating systems complete with:

- Fix point regulating unit
- Low temperature distribution manifolds, from 2 up to 12 outlets
- Fixing brackets, art.7480
- Safety thermostat

Art.3483

Pre-assembled mixed unit for underfloor heating systems complete with:

- Fix point regulating unit
- Low temperature distribution manifolds, from 3 up to 10 outlets
- High temperature distribution manifolds
- Fixing brackets, art.7480
- Safety thermostat

Art.3482

Pre-assembled unit for underfloor heating systems complete with:

- Fix point regulating unit
- Low temperature distribution manifolds, from 3 up to 12 outlets
- Fixing brackets, art.7480
- Painted sheet steel wall box
- Safety thermostat

Art.3484

Pre-assembled mixed unit for underfloor heating systems complete with:

- Fix point regulating unit
- Low temperature distribution manifolds, from 3 up to 11 outlets
- High temperature distribution manifolds
- Fixing brackets, art.7480
- Painted sheet steel wall box
- Safety thermostat

Art.3568

Pre-assembled unit for underfloor heating systems complete with:

- Mixing valve with 3-point actuator
- Low temperature distribution manifolds, from 5 up to 12 outlets
- Fixing brackets, art.7480
- Painted sheet steel wall box
- Safety thermostat

Art.3570

Pre-assembled mixed unit for underfloor heating systems complete with:

- Mixing valve with 3-point actuator
- Low temperature distribution manifolds, from 5 up to 11 outlets
- High temperature distribution manifolds
- Fixing brackets, art.7480
- Painted sheet steel wall box
- Safety thermostat

The range also includes pre-assembled units with flowmeters and balancing manifolds, arts. 3566-3567 (see our catalogue).

## 7. FLUID DYNAMICS FEATURES

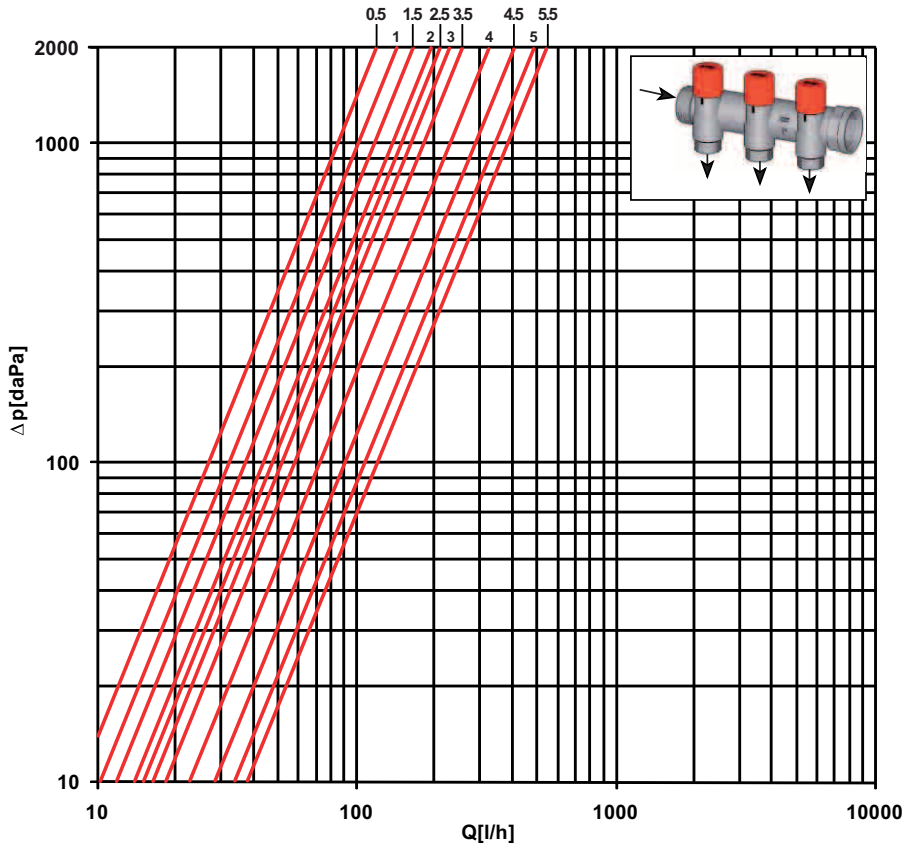

POSITION	0,5	1	1,5	2	2,5	3	3,5	4	4,5	5	5,5
Kv [m³/h]	0,27	0,32	0,38	0,43	0,47	0,51	0,61	0,73	0,90	1,1	1,26
Kv 0,2 [l/min]	1,9	2,4	2,8	3,2	3,5	3,8	4,5	5,45	6,71	8	9

## 8. DIMENSIONAL AND TECHNICAL FEATURES

### Dimensional Features

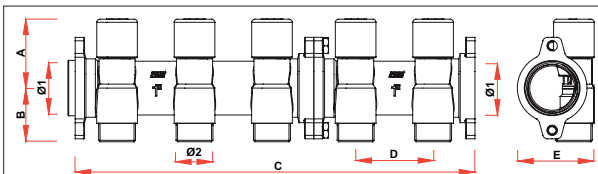

CODE	PORTS	Ø1	A	B	C	D	E	Ø2
3915-3918	2	G1	45	35	105	50	50	24x19-G3/4
3915-3918	3	G1	45	35	155	50	50	24x19-G3/4
3915-3918	4	G1	45	35	205	50	50	24x19-G3/4
3915-3918	5	G1	45	35	260	50	50	24x19-G3/4
3915-3918	6	G1	45	35	310	50	50	24x19-G3/4
3915-3918	7	G1	45	35	360	50	50	24x19-G3/4
3915-3918	8	G1	45	35	410	50	50	24x19-G3/4
3915-3918	9	G1	45	35	465	50	50	24x19-G3/4
3915-3918	10	G1	45	35	515	50	50	24x19-G3/4
3915-3918	11	G1	45	35	565	50	50	24x19-G3/4
3915-3918	12	G1	45	35	615	50	50	24x19-G3/4

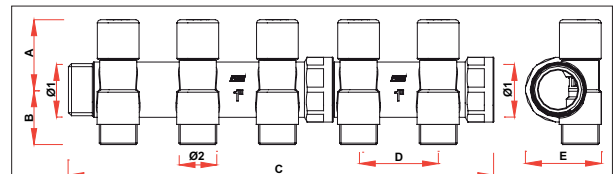

CODE	PORTS	Ø1	A	B	C	D	E	Ø2
3923-3921	2	G1	45	34	116	50	48	24x19-G1/2-G3/4
3923-3921	3	G1	45	34	166	50	48	24x19-G1/2-G3/4
3923-3921	4	G1	45	34	216	50	48	24x19-G1/2-G3/4
3923-3921	5	G1	45	34	268	50	48	24x19-G1/2-G3/4
3923-3921	6	G1	45	34	318	50	48	24x19-G1/2-G3/4
3923-3921	7	G1	45	34	368	50	48	24x19-G1/2-G3/4
3923-3921	8	G1	45	34	418	50	48	24x19-G1/2-G3/4
3923-3921	9	G1	45	34	470	50	48	24x19-G1/2-G3/4
3923-3921	10	G1	45	34	520	50	48	24x19-G1/2-G3/4
3923-3921	11	G1	45	34	570	50	48	24x19-G1/2-G3/4
3923-3921	12	G1	45	34	620	50	48	24x19-G1/2-G3/4
3923-3921	2	G1 1/4	50	38	116	50	58	24x19-G3/4
3923-3921	3	G1 1/4	50	38	166	50	58	24x19-G3/4
3923-3921	4	G1 1/4	50	38	218	50	58	24x19-G3/4
3923-3921	5	G1 1/4	50	38	268	50	58	24x19-G3/4
3923-3921	6	G1 1/4	50	38	318	50	58	24x19-G3/4
3923-3921	7	G1 1/4	50	38	368	50	58	24x19-G3/4
3923-3921	8	G1 1/4	50	38	418	50	58	24x19-G3/4
3923-3921	9	G1 1/4	50	38	470	50	58	24x19-G3/4
3923-3921	10	G1 1/4	50	38	520	50	58	24x19-G3/4
3923-3921	11	G1 1/4	50	38	570	50	58	24x19-G3/4
3923-3921	12	G1 1/4	50	38	620	50	58	24x19-G3/4

### Technical Features

Max. working pressure: 10 bar
Max. working temperature: 95°C
Compatible media: Water and water with glycol

## По вопросам продаж и поддержки обращайтесь:

Алматы (7273)495-231  
Ангарск (3955)60-70-56  
Архангельск (8182)63-90-72  
Астрахань (8512)99-46-04  
Барнаул (3852)73-04-60  
Белгород (4722)40-23-64  
Благовещенск (4162)22-76-07  
Брянск (4832)59-03-52  
Владивосток (423)249-28-31  
Владикавказ (8672)28-90-48  
Владимир (4922)49-43-18  
Волгоград (844)278-03-48  
Вологда (8172)26-41-59  
Воронеж (473)204-51-73  
Екатеринбург (343)384-55-89

Иваново (4932)77-34-06  
Ижевск (3412)26-03-58  
Иркутск (395)279-98-46  
Казань (843)206-01-48  
Калининград (4012)72-03-81  
Калуга (4842)92-23-67  
Кемерово (3842)65-04-62  
Киров (8332)68-02-04  
Коломна (4966)23-41-49  
Кострома (4942)77-07-48  
Краснодар (861)203-40-90  
Красноярск (391)204-63-61  
Курск (4712)77-13-04  
Курган (3522)50-90-47  
Липецк (4742)52-20-81

Магнитогорск (3519)55-03-13  
Москва (495)268-04-70  
Мурманск (8152)59-64-93  
Набережные Челны (8552)20-53-41  
Нижний Новгород (831)429-08-12  
Новокузнецк (3843)20-46-81  
Ноябрьск (3496)41-32-12  
Новосибирск (383)227-86-73  
Омск (3812)21-46-40  
Орел (4862)44-53-42  
Оренбург (3532)37-68-04  
Пенза (8412)22-31-16  
Петрозаводск (8142)55-98-37  
Псков (8112)59-10-37  
Пермь (342)205-81-47

Ростов-на-Дону (863)308-18-15  
Рязань (4912)46-61-64  
Самара (846)206-03-16  
Санкт-Петербург (812)309-46-40  
Саратов (845)249-38-78  
Севастополь (8692)22-31-93  
Саранск (8342)22-96-24  
Симферополь (3652)67-13-56  
Смоленск (4812)29-41-54  
Сочи (862)225-72-31  
Ставрополь (8652)20-65-13  
Сургут (3462)77-98-35  
Сыктывкар (8212)25-95-17  
Тамбов (4752)50-40-97  
Тверь (4822)63-31-35

Тольятти (8482)63-91-07  
Томск (3822)98-41-53  
Тула (4872)33-79-87  
Тюмень (3452)66-21-18  
Ульяновск (8422)24-23-59  
Улан-Уда (3012)59-97-51  
Уфа (347)229-48-12  
Хабаровск (4212)92-98-04  
Чебоксары (8352)28-53-07  
Челябинск (351)202-03-61  
Череповец (8202)49-02-64  
Чита (3022)38-34-83  
Якутск (4112)23-90-97  
Ярославль (4852)69-52-93

Россия +7(495)268-04-70

Казахстан +7(7172)727-132

Киргизия +996(312)96-26-47

эл.почта: [fro@nt-rt.ru](mailto:fro@nt-rt.ru) || сайт: <https://far.nt-rt.ru/>